



# Product catalogue 2013

<b>34° Framing Nailers</b>	<b>3</b>
<b>Anchor Nailers</b>	<b>11</b>
<b>21° Framing Nailers</b>	<b>17</b>
<b>Coil Nailers</b>	<b>21</b>
<b>Haften Nailers</b>	<b>31</b>
<b>Corrugated Nailers</b>	<b>35</b>
<b>Concrete Nailers</b>	<b>37</b>
<b>Brad and Finish Nailers</b>	<b>41</b>
<b>Staplers</b>	<b>55</b>
<b>Repair and service</b>	<b>67</b>
<b>Conversion Table</b>	<b>69</b>

# Complete range of gas-powered tools for professional use

## Second generation gas nailers!

See the most important changes here in the catalogue or try out the nailers at your nearest dealer, and experience high power and maximum freedom of movement.

TJEP gas technology is modern design and high quality in one. A well-balanced and ergonomic gas nailer lets you forget everything about compressors, hoses and heavy battery systems.

It doesn't get easier!



Read more about **TJEP GRF 34/90 GAS 2G** for 34° strip nails on page 4



Read more about **TJEP GRF 34/105 GAS** for 34° strip nails on page 5



Read more about **TJEP KA 4060 GAS 2G** for 34° anchor nails on page 13



Read more about **TJEP FH 21/90 GAS 2G** for 21° strip nails on page 18



Read more about **TJEP HA-35 GAS 2G** for HA haften nails on page 32



Read more about **TJEP CP-40 GAS 2G** for 0° concrete nails on page 38



Read more about **TJEP TF-18/50 GAS 2G** for 1.2 mm 0° brads on page 43



Read more about **TJEP VF-16/64 GAS 2G** for 1.6 mm 20° finish nails on page 46



Read more about **TJEP TF-16/64 GAS 2G** for 1.6 mm 0° finish nails on page 49



Read more about **TJEP AB-15/64 GAS** for 1.8 mm 34° finish nails on page 51



Read more about **TJEP PQZ-75 GAS 2G** for PQ and PZ staples on page 63



# 34° Framing Nailers

## Nailers

TJEP GRF 34/90 GAS 2G .....	4
TJEP GRF 34/105 GAS.....	5
TJEP GRF 34/90 LW .....	6
TJEP GRF 34/100 .....	6
TJEP GRF 100 Compact XP .....	7

## Fasteners

TJEP GF nails .....	8
TJEP DE nails .....	8
TJEP GR nails .....	9



# TJEP GRF 34/90 GAS 2G



High power  
91 joules

**New 2012 model**

- New handle, better support
- New air filter, less maintenance
- New safety bracket, improved trigger

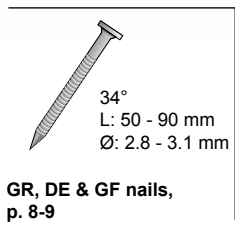
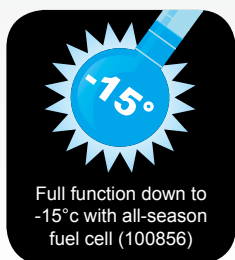

- 1 Well-balanced
- 2 Adjustable depth control
- 3 Rubber pad – anti-skid
- 4 Easy to clean
- 5 Rafter/belt hook

**Specifications**

Item no.	100806
EAN no.	5702551008065
Nail length	50 - 90 mm
Size (LxWxH)	375 x 108 x 372 mm
Weight incl. battery	3.63 kg

Supplied with 2 batteries and charger in plastic case.

**Accessories**

Description	Item no.
TJEP fuel cell, 165 mm, orange ring	100853
TJEP all-season fuel cell, 165 mm, red ring (-15°C)	100856
TJEP battery, 1.65 Ah NiMh	100842
TJEP charger for TJEP battery, 1.65 Ah NiMh	100840
Decra Safety bracket	100849
Wood flooring probe	100846
No-mark set, 5 pcs.	871090

**Used for**

raftering, plywood, laths, siding, flooring, boarding, decking





# TJEP GRF 34/105 GAS



Most powerful gas nailer  
on the market – 135 joules

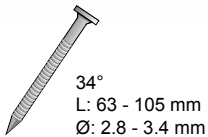
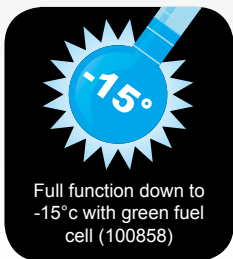

GR & GF nails, p. 8-9

- 1 Very powerful
- 2 Great balance
- 3 Adjustable depth control
- 4 Rubber pad – anti-skid
- 5 Easy to clean
- 6 Rafter/belt hook

## Specifications

Item no.	100800
EAN no.	5702551008003
Nail length	63 - 105 mm
Size (LxWxH)	565 x 115 x 440 mm
Weight incl. battery	4.60 kg

Supplied with 2 batteries and charger in plastic case.

## Accessories

Description	Item no.
TJEP fuel cell, 165 mm, green ring	100858
TJEP battery, 1.65 Ah NiMh	100842
TJEP charger for TJEP battery, 1.65 Ah NiMh	100840

## Used for

raftering, roof battening, plywood, laths, siding, flooring, boarding



## TJEP GRF 34/90 LW



New, lighter version  
only 3,30 kg

Introduced in 2013

## TJEP GRF 34/100



Up to 98 mm ring shank  
nails, also in hardwood

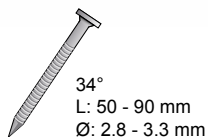

GR & GF nails, p. 8-9

- 1 Compact design
- 2 Lightweight
- 3 Single shot or bump fire
- 4 Adjustable depth control
- 5 Adjustable air exhaust
- 6 No-mark pad

### Specifications

Item no.	100099
EAN no.	5702551000991
Nail length	50 - 90 mm
Air consumption per cycle	3.0 litres
Size (LxWxH)	480 x 121 x 340 mm
Weight	3.30 kg

### Accessories

Description	Item no.
Air tool lube X-1R 100 ml	106229

### Used for

raftering, roof battening, laths, boarding, flooring, siding

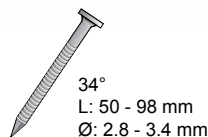

GR & GF nails, p. 8-9

- 1 Single shot or bump fire
- 2 Adjustable air exhaust
- 3 Non-slip grip / less hand fatigue
- 4 Adjustable depth control
- 5 No-mark pad

### Specifications

Item no.	100085
EAN no.	5702551000854
Nail length	50 - 98 mm
Air consumption per cycle	3.0 litres
Size (LxWxH)	508 x 154 x 373 mm
Weight	3.80 kg

### Accessories

Description	Item no.
Air tool lube X-1R 100 ml	106229

### Used for

raftering, roof battening, laths, outside siding, panelling, boarding, flooring

# TJEP GRF 100 Compact XP



The craftman's preferred  
4" framing nailer

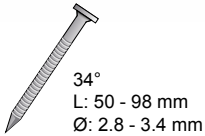

GR & GF nails, p. 8-9

- 1 Compact design
- 2 Great balance
- 3 Adjustable air exhaust
- 4 Adjustable depth control
- 5 Rear two-step loading
- 6 No-mark pad

## Specifications

Item no.	100082
EAN no.	5702551000823
Nail length	50 - 98 mm
Air consumption per cycle	3.0 litres
Size (LxWxH)	449 x 141 x 364 mm
Weight	3.54 kg

## Accessories

Description	Item no.
Flooring nose piece	872198
Air tool lube X-1R 100 ml	106229

## Used for

raftering, roof battening, laths, boarding, flooring, siding





# TJEP GF and DE nails, 34°



Full head



Wide range of  
TJEP full head nails

## GF and DE nails fit

<b>TJEP</b>	GRF 34/105 GAS, GRF 34/90 GAS, GRF 34/100, GRF 100 Compact XP, GN 100 Compact, GN 100, GRF 34/90
<b>Paslode</b>	PSN100, F-400, F-350, GN 5350, IM350/90, IM90i, PSN98, IM100i
<b>MAX</b>	GS-690 CH

## Ring shank nails with full head – Handybox

Dimension	Item no.	Pcs/box	Weight	Box/pallet
GF 28/50	833050	1,200	3.27 kg	120
GF 28/63	833063	1,200	4.07 kg	120
GF 28/75	833075	810	3.25 kg	120
GF 31/90	833090	810	4.46 kg	120
GF 31/98	833098	810	5.08 kg	120

## Ring shank nails with full head – A4 stainless – Handybox

Dimension	Item no.	Pcs/box	Weight	Box/pallet
GF 28/63	833363	1,200	3.85 kg	120
GF 28/80	833380	810	3.26 kg	120
GF 31/98	833398	810	4.79 kg	120

## Smooth shank nails with full head – Maxibox

Dimension	Item no.	Pcs/box	Weight	Box/pallet
GF 31/90	833287	2,000	10.59 kg	60
GF 31/90	833187	2,000	10.59 kg	60

## Ring shank nails with full head – Maxibox

Dimension	Item no.	Pcs/box	Weight	Box/pallet
GF 28/63	833163	3,000	9.50 kg	60
GF 28/75	833175	2,500	9.36 kg	60
GF 28/80	833180	2,500	9.94 kg	60

## Decra ring shank nails with full head – Handybox

Dimension	Item no.	Pcs/box	Weight	Box/pallet
DE 25/50 black	833051	1,200	2.68 kg	120
DE 25/50 red	833052	1,200	2.68 kg	120



All TJEP nails for bearing structures manufactured after 1 August 2010 are CE-marked and meet the requirements of Eurocode 5 and standard 14592.

■ Bright
 ■ Galv.
 ■ Galv., 12µ
 ■ HDG
 ■ Stainless

# TJEP GR nails, 34°



D-head

TJEP D-head nails  
for any task ...



## GR nails fit

<b>TJEP</b>	GRF 34/105 GAS, GRF 34/90 GAS, GRF 34/100, GRF 100 Compact XP, GN 100 Compact, GN 100, GRF 34/90
<b>Paslode</b>	PSN100, F-400, F-350, GN 5350, IM350/90, IM90i, PSN98, IM100i
<b>Senco MAX</b>	FP651, SP80, GT 90 CH, SN 951 DO GS-690 CH, SN 890 CH

## Ring shank nails with D-head – Jumbobox

Dimension	Item no.	Pcs/box	Weight	Box/pallet
■ GR 28/50	834850	6,000	18.90 kg	48
■ GR 28/63	834863	4,600	17.29 kg	48
■ GR 28/75	834875	4,000	17.58 kg	48
■ GR 31/90	834890	3,000	17.45 kg	48
■ GR 31/98	834898	2,800	18.07 kg	48

## Smooth shank nails with D-head – Maxibox

Dimension	Item no.	Pcs/box	Weight	Box/pallet
■ GR 28/63	834264	2,500	7.79 kg	60
■ GR 28/75	834276	2,000	7.39 kg	60
■ GR 28/80	834281	2,000	7.87 kg	60
■ GR 31/80	834282	1,800	8.80 kg	60
■ GR 31/90	834291	1,800	9.46 kg	60
■ GR 34/100	834299	1,600	10.45 kg	60
■ GR 31/90	834191	1,800	9.50 kg	60

## Ring shank nails with D-head – Maxibox

Dimension	Item no.	Pcs/box	Weight	Box/pallet
■ GR 28/50	834250	3,500	8.70 kg	60
■ GR 28/63	834263	2,500	7.79 kg	60
■ GR 28/75	834277	2,000	7.40 kg	60
■ GR 28/80	834283	2,000	7.90 kg	60
■ GR 31/75	834275	2,000	8.97 kg	60
■ GR 31/80	834284	1,800	8.80 kg	60
■ GR 31/90	834290	1,800	9.46 kg	60
■ GR 31/98	834298	1,800	10.52 kg	60
■ GR 28/51	834150	3,500	8.70 kg	60
■ GR 28/63	834163	2,500	7.40 kg	60
■ GR 28/75	834175	2,000	7.80 kg	60
■ GR 31/90	834190	1,800	9.50 kg	60
■ GR 34/100	834199	1,600	10.50 kg	60
■ GR 28/50	834050	3,500	9.31 kg	60
■ GR 28/63	834063	2,500	8.33 kg	60
■ GR 28/75	834075	2,000	7.90 kg	60
■ GR 31/90	834090	1,800	10.12 kg	60
■ GR 31/98	834098	1,800	11.26 kg	60



All TJEP nails for bearing structures manufactured after 1 August 2010 are CE-marked and meet the requirements of Eurocode 5 and standard 14592.

■ Bright ■ Galv. ■ Galv., 12µ ■ HDG ■ Stainless

**Did you know ...**  
**... that at [www.tjep.eu](http://www.tjep.eu)**  
**you can see which nails**  
**and accessories fit the**  
**specific tools?**

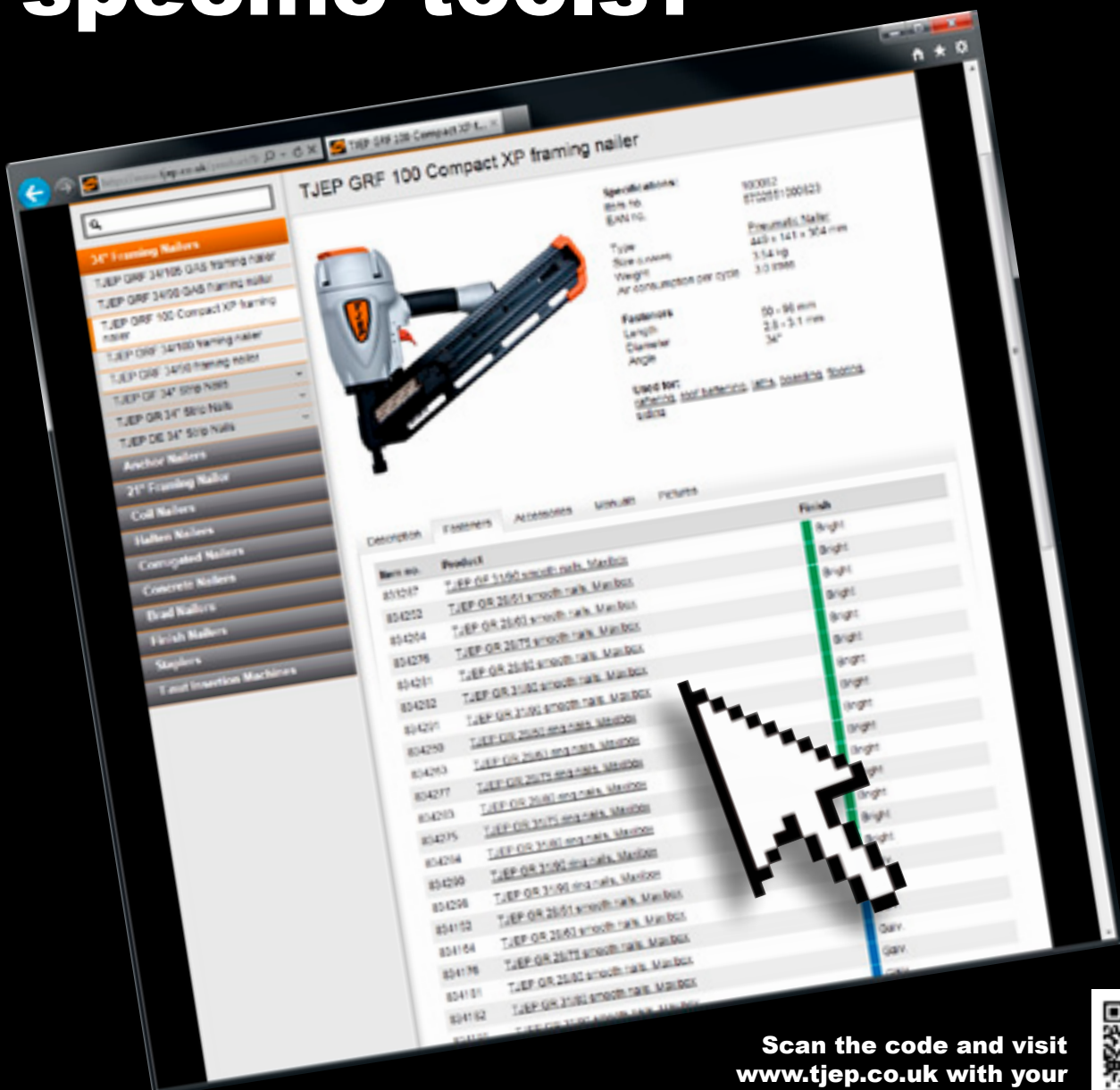

Scan the code and visit  
[www.tjep.co.uk](http://www.tjep.co.uk) with your  
mobile phone or tablet (iPad)







# Anchor Nailers

## Nailers

TJEP BC 60 .....	12
TJEP KA 4060 GAS 2G .....	13
TJEP KA 1 .....	14
TJEP KA 1L .....	14
TJEP KA 2 .....	15

## Fasteners

TJEP BC nails .....	12
TJEP KA nails .....	15

# TJEP BC 60

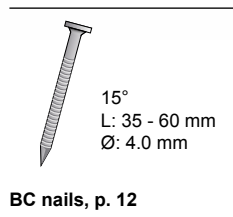

BC nails, p. 12

- 1 100 nails per coil
- 2 Adjustment of magazine height
- 3 Ergonomic rubber grip
- 4 Adjustable air exhaust
- 5 Adjustable depth control
- 6 Belt hook

### Specifications

Item no.	100091
EAN no.	5702551000915
Nail length	35 - 60 mm
Air consumption per cycle	2.5 litres
Size (LxWxH)	278 x 100 x 317 mm
Weight	2.35 kg

### Accessories

Description	Item no.
Air tool lube X-1R 100 ml	106229

### Used for

metal connector plates



# TJEP BC nails, 15°



Full head



### BC nails fit

TJEP MAX	BC 60 HN-65J
-------------	-----------------

### BC anchor nails

Dimension	Item no.	Pcs/box	Weight	Box/pallet
BC 40/35	837135	1,600	5.54 kg	60
BC 40/40	837141	1,600	6.34 kg	60
BC 40/50	837151	1,200	5.95 kg	60
BC 40/60	837161	800	4.77 kg	60
BC 40/40	837041	1,600	6.79 kg	60

**CE** All TJEP nails for bearing structures manufactured after 1 August 2010 are CE-marked and meet the requirements of Eurocode 5 and standard 14592.

■ Bright  
 ■ Galv.  
 ■ Galv., 12µ  
 ■ HDG  
 ■ Stainless

# TJEP KA 4060 GAS 2G



**New 2012 model**

- New handle, better support
- New air filter, less maintenance

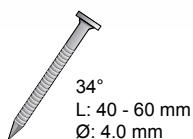
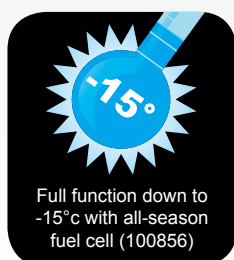

KA nails, p. 15

- 1 Precise insertion in nail plates
- 2 Non-slip grip / less hand fatigue
- 3 Adjustable depth control
- 4 Rafter/belt hook
- 5 Rear two-step loading

## Specifications

Item no.	100831
EAN no.	5702551008317
Nail length	40 - 60 mm
Size (LxWxH)	364 x 115 x 392 mm
Weight incl. battery	3.75 kg

Supplied with 2 batteries and charger in plastic case.

## Accessories

Description	Item no.
TJEP fuel cell, 165 mm, orange ring	100853
TJEP all-season fuel cell, 165 mm, red ring (-15°C)	100856
TJEP battery 1.65 Ah NiMh	100842
TJEP charger for TJEP battery, 1.65 Ah NiMh	100840

## Used for

metal connector plates





## TJEP KA 1



Easy access everywhere

## TJEP KA 1L



Long magazine with room for two nail strips

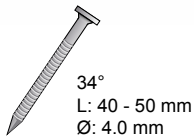

KA nails, p. 15

- 1 Compact outer dimensions
- 2 Drives the nail in with short punches
- 3 No risk of ricochets
- 4 Shock-absorbing rubber handle
- 5 Rubber collar

### Specifications

Item no.	100324
EAN no.	5702551003244
Nail length	40 - 50 mm
Air consumption per cycle	3.0 litres
Size (LxWxH)	277 x 112 x 254 mm
Weight	1.88 kg

### Accessories

Description	Item no.
Air tool lube X-1R 100 ml	106229

### Used for

metal connector plates

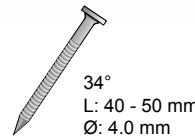

KA nails, p. 15

- 1 Compact outer dimensions
- 2 Drives the nail in with short punches
- 3 No risk of ricochets
- 4 Shock-absorbing rubber handle
- 5 Room for two nail strips

### Specifications

Item no.	100323
EAN no.	5702551003237
Nail length	40 - 50 mm
Air consumption per cycle	3.0 litres
Size (LxWxH)	437 x 112 x 254 mm
Weight	2.04 kg

### Accessories

Description	Item no.
Air tool lube X-1R 100 ml	106229

### Used for

metal connector plates

## TJEP KA 2



Easy access every-  
where with nails up to  
60 mm

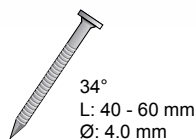

KA nails, p. 15

- 1 Compact outer dimensions
- 2 Drives the nail in with short punches
- 3 No risk of ricochets
- 4 Shock-absorbing rubber handle
- 5 Rubber collar

### Specifications

Item no.	100329
EAN no.	5702551003299
Nail length	40, 50, 60 mm
Air consumption per cycle	4.6 litres
Size (LxWxH)	287 x 118 x 279 mm
Weight	2.36 kg

### Accessories

Description	Item no.
Air tool lube X-1R 100 ml	106229

### Used for

metal connector plates

## TJEP KA nails, 34°



Full head



### KA nails fit

<b>TJEP</b>	KA 4060 GAS, KA 2, KA 1, KA 1L, BS-2, BS-1, BS-1L
<b>Paslode</b>	BS 4040, PSN 50NP, F250S-PP
<b>Senco</b>	MC 60, 4PRO-BS4060

### KA anchor nails

Dimension	Item no.	Pcs/box	Weight	Box/pallet
KA 40/40	837140	2,400	11.60 kg	52
KA 40/50	837150	1,800	9.80 kg	52
KA 40/60	837160	1,600	10.20 kg	52
KA 40/40	837040	2,400	11.20 kg	52

### KA anchor nails, A4 stainless

Dimension	Item no.	Pcs/box	Weight	Box/pallet
KA 40/40	837340	2,400	10.70 kg	52



All TJEP nails for bearing structures manufactured after 1 August 2010 are CE-marked and meet the requirements of Eurocode 5 and standard 14592.

■ Bright
 ■ Galv.
 ■ Galv., 12µ
 ■ HDG
 ■ Stainless

**Did you know ...**  
**... that at [www.tjep.eu](http://www.tjep.eu)**  
**you can see the entire**  
**TJEP product range?**



Scan the code and visit  
[www.tjep.co.uk](http://www.tjep.co.uk) with your  
mobile phone or tablet (iPad)







# 21° Framing Nailers

## Nailers

TJEP FH 21/90 GAS 2G.....	18
TJEP FH 130 .....	19
TJEP FH 160 .....	19
TJEP FH 21/90 LW .....	20

## Fasteners

TJEP FH nails.....	20
--------------------	----

# TJEP FH 21/90 GAS 2G

**New 2012 model**

- New handle, better support
- New air filter, less maintenance
- New safety bracket, improved trigger

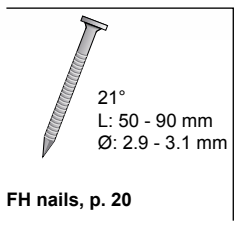
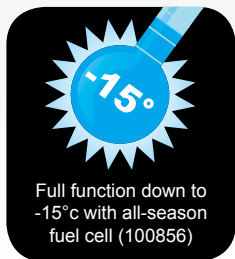

- 1 Rafter/belt hook
- 2 Non-slip grip
- 3 Rear two-step loading
- 4 Rubber pad – anti-skid
- 5 Adjustable depth control
- 6 Great balance

**Specifications**

Item no.	100875
EAN no.	5702551008751
Nail length	50 - 90 mm
Size (LxWxH)	332 x 126 x 310 mm
Weight incl. battery	3.57 kg

Supplied with 2 batteries and charger in plastic case.

**Accessories**

Description	Item no.
TJEP fuel cell, 165 mm, orange ring	100853
TJEP all-season fuel cell, 165 mm, red ring (-15°C)	100856
TJEP battery, 1.65 Ah NiMh	100842
TJEP charger for TJEP battery, 1.65 Ah NiMh	100840

**Used for**

laths, roof battening, decking, siding, flooring, boarding



## TJEP FH 130

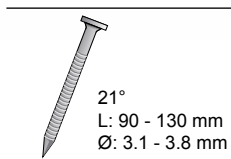

FH nails, p. 20

- 1 Top load
- 2 Non-slip grip
- 3 Low noise
- 4 Very low recoil
- 5 Adjustable depth control
- 6 Extra handle on the side

### Specifications

Item no.	100089
EAN no.	5702551000892
Nail length	90 - 130 mm
Air consumption per cycle	4.4 litres
Size (LxWxH)	536 x 150 x 457 mm
Weight	6.10 kg

### Accessories

Description	Item no.
Air tool lube X-1R 100 ml	106229

### Used for

roof battening, laths, siding, decking, boarding, wood frames

## TJEP FH 160

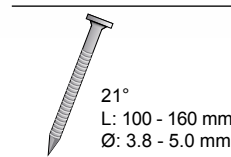

FH nails, p. 20

- 1 Top load
- 2 Non-slip grip
- 3 Low noise
- 4 Very low recoil
- 5 Adjustable depth control
- 6 Extra handle on the side

### Specifications

Item no.	100088
EAN no.	5702551000885
Nail length	100 - 160 mm
Air consumption per cycle	5.4 litres
Size (LxWxH)	554 x 150 x 506 mm
Weight	6.80 kg

### Accessories

Description	Item no.
Air tool lube X-1R 100 ml	106229

### Used for

roof battening, laths, siding, decking, boarding, wood frames

# TJEP FH 21/90 LW



New, lighter version  
only 3,30 kg

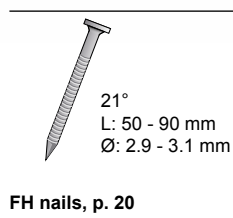

FH nails, p. 20

- 1 Single shot or bump fire
- 2 Rafter/belt hook
- 3 Adjustable air exhaust
- 4 Rear two-step loading
- 5 Adjustable depth control

## Specifications

Item no.	100098
EAN no.	5702551000984
Nail length	50 - 90 mm
Air consumption per cycle	3.0 litres
Size (LxWxH)	540.4 x 121 x 335.3 mm
Weight	3.30 kg

## Accessories

Description	Item no.
Air tool lube X-1R 100 ml	106229

## Used for

roof battening, siding, decking, boarding

# TJEP FH nails

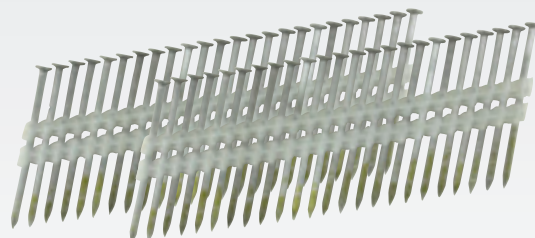

## FH nails fit

<b>TJEP</b>	FH 160, FH 130, FH 21/90, FH 21/90 GAS, FH 4, FH 35
<b>Duo-Fast</b>	CN400, CN350, NSP 350F
<b>Senco</b>	FP652, SNI 302, GT 90 FRH, STN 130
<b>MAX</b>	GT90FRH, GS-690RH

## Smooth shank nails with full head

Dimension	Item no.	Pcs/box	Weight	Box/pallet
FH 38/130	107403	1,250	14.54 kg	75
FH 42/160	838260	660	11.45 kg	60

## Ring shank nails with full head

Dimension	Item no.	Pcs/box	Weight	Box/pallet
FH 38/120	838033	1,400	15.80 kg	60
FH 38/130	107409	1,250	14.54 kg	75
FH 29/50	107450	1,200	3.21 kg	120
FH 29/64	107453	1,200	4.48 kg	120
FH 29/76	107456	1,200	4.76 kg	120
FH 31/90	107459	1,200	6.54 kg	120
FH 31/98	107462	1,000	6.28 kg	120
FH 38/130	107464	1,250	14.05 kg	75

## Twisted nails with full head

Dimension	Item no.	Pcs/box	Weight	Box/pallet
FH 42/160	838160	660	16.00 kg	60



All TJEP nails for bearing structures manufactured after 1 August 2010 are CE-marked and meet the requirements of Eurocode 5 and standard 14592.

■ Bright  
 ■ Galv.  
 ■ Galv., 12µ  
 ■ HDG  
 ■ Stainless





# Coil Nailers

## Nailers

TJEP TA 45 .....	22
TJEP MX 50 .....	23
TJEP ZE 65 .....	24
TJEP PC 66 .....	26
TJEP PC 90 .....	26
TJEP CN 57 .....	28
TJEP CN 70 .....	28
TJEP CN 100 EPAL .....	29

## Fasteners

TJEP TA nails .....	22
TJEP MX nails .....	23
TJEP ZE nails .....	25
TJEP PC nails .....	27

# TJEP TA 45



Great for roofing felt

# TJEP TA nails



Roofing felt nails

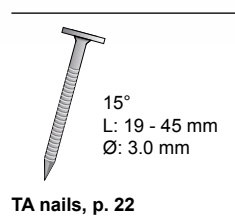

TA nails, p. 22

- 1 Adjustable air exhaust
- 2 Single shot or bump fire
- 3 Safety grip
- 4 Adjustment of magazine height
- 5 Protection plate - non-slip
- 6 Adjustable depth control

### Specifications

Item no.	100345
EAN no.	5702551003459
Nail length	19 - 45 mm
Air consumption per cycle	1.4 litres
Size (LxWxH)	294 x 116 x 276 mm
Weight	1.50 kg

### Accessories

Description	Item no.
Air tool lube X-1R 100 ml	106229

### Used for

roofing felt, wind barriers, thin metal plates, covering



### TA nails fit

<b>TJEP</b>	TA 45
<b>Paslode</b>	3175/45
<b>Senco</b>	SCN 40R, RP 450, RP 455
<b>Haubold</b>	RNC 45 R
<b>MAX</b>	CN 450 R

### Ring shank nails with full head

Dimension	Item no.	Pcs/box	Weight	Box/pallet
TA 30/19	836119	3,840	4.59 kg	96
TA 30/25	836125	2,880	4.55 kg	120
TA 30/32	836132	1,920	3.88 kg	144
TA 30/19	836019	3,840	4.59 kg	96
TA 30/25	836025	2,880	4.55 kg	120
TA 30/38	836038	1,920	5.00 kg	120

### Ring shank nails with full head – Stainless A2

Dimension	Item no.	Pcs/box	Weight	Box/pallet
TA 30/25	836325	2,880	4.55 kg	120

**CE** All TJEP nails for bearing structures manufactured after 1 August 2010 are CE-marked and meet the requirements of Eurocode 5 and standard 14592.

■ Bright   
 ■ Galv.   
 ■ Galv., 12µ   
 ■ HDG   
 ■ Stainless

## TJEP MX 50



15°  
L: 25 - 50 mm  
Ø: 2.1 mm

MX nails, p. 23

- 1 Adjustable air exhaust
- 2 Single shot or bump fire
- 3 Adjustment of magazine height
- 4 Low noise
- 5 No-mark pad
- 6 Adjustable depth control

### Specifications

Item no.	100050
EAN no.	5702551000502
Nail length	25 - 50 mm
Air consumption per cycle	1.4 litres
Size (LxWxH)	260 x 108 x 302 mm
Weight	1.50 kg

### Accessories

Description	Item no.
Air tool lube X-1R 100 ml	106229

### Used for

siding, wood frames, decking, boarding

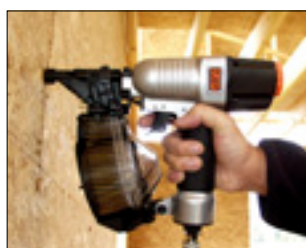

## TJEP MX nails



### MX nails fit

<b>TJEP</b>	MX 50
<b>MAX</b>	CN-452, CN 238, HN 50
<b>Haubold</b>	RNC 50 M1
<b>Senco</b>	SCN 45, SCN 48

### Ring shank nails with full head

Dimension	Item no.	Pcs/box	Weight	Box/pallet
■ MX 21/25	839025	4,000	2.82 kg	60
■ MX 21/30	839030	3,200	2.68 kg	60
■ MX 21/35	839035	3,200	3.10 kg	60
■ MX 21/40	839040	2,400	2.81 kg	60
■ MX 21/45	839045	2,400	3.16 kg	60
■ MX 21/50	839050	2,400	3.51 kg	60

### Ring shank nails, A4 stainless, lens head

Dimension	Item no.	Pcs/box	Weight	Box/pallet
■ MX 21/25	839325	4,000	2.87 kg	60
■ MX 21/35	839335	3,200	3.16 kg	60
■ MX 21/50	839350	2,400	3.28 kg	60

### Ring shank nails with full head and blunt point

Dimension	Item no.	Pcs/box	Weight	Box/pallet
■ MX 21/45	839046	2,400	3.16 kg	60
■ MX 21/45	839346	2,400	2.95 kg	60

**CE** All TJEP nails for bearing structures manufactured after 1 August 2010 are CE-marked and meet the requirements of Eurocode 5 and standard 14592.

■ Bright ■ Galv. ■ Galv., 12µ ■ HDG ■ Stainless

# TJEP ZE 65



Also suitable for Decra etc.

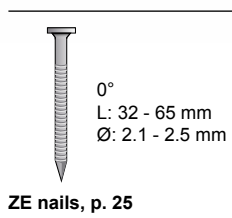

- 1 Single shot or bump fire
- 2 Adjustable air exhaust
- 3 Belt hook
- 4 Plastic-collated nails
- 5 No-mark pad
- 6 Adjustable depth control

## Specifications

Item no.	100143
EAN no.	5702551001431
Nail length	32 - 65 mm
Air consumption per cycle	2.3 litres
Size (LxWxH)	300 x 145 x 316 mm
Weight	2.30 kg

## Accessories

Description	Item no.
Decra safety bracket	850251
Air tool lube X-1R 100 ml	106229

## Used for

outside siding, boarding, panelling, decking, Decra roofing





# TJEP ZE nails



## ZE nails fit

TJEP Duo-Fast	ZE 65 CNP 50, CNP 65, CNP 75

## Ring shank nails with full head

Dimension	Item no.	Pcs/box	Weight	Box/pallet
■ ZE 21/40	835240	1,950	2.23 kg	69
■ ZE 21/50	835250	1,950	2.76 kg	69
■ ZE 25/45	835245	1,950	3.39 kg	69
■ ZE 25/50	835251	1,950	3.77 kg	69
■ ZE 25/65	835265	1,300	3.26 kg	69
■ ZE 25/75*	835275	1,300	3.76 kg	69
■ ZE 21/35	835035	2,600	3.00 kg	69
■ ZE 21/40	835040	1,950	3.05 kg	69
■ ZE 21/45	835045	1,950	3.50 kg	69
■ ZE 21/50	835050	1,950	3.70 kg	69
■ ZE 25/50	835051	1,950	4.03 kg	69
■ ZE 25/65	835065	1,300	3.49 kg	69
■ ZE 25/75*	835075	1,300	4.03 kg	69

## Ring shank nails, A4 stainless, lens head

Dimension	Item no.	Pcs/box	Weight	Box/pallet
■ ZE 21/50	835350	1,950	2.76 kg	69
■ ZE 25/50	835351	1,950	3.77 kg	69
■ ZE 25/65	835365	1,300	3.26 kg	69
■ ZE 25/75*	835375	1,300	3.76 kg	69

## Ring shank nails, A2 lens head

Dimension	Item no.	Pcs/box	Weight	Box/pallet
■ ZE 25/50	835450	1,950	3.77 kg	69
■ ZE 25/65	835465	1,300	3.26 kg	69

## Decra ring shank nails with full head

Dimension	Item no.	Pcs/box	Weight	Box/pallet
■ ZE 25/50 black	835252	1,950	4.03 kg	69
■ ZE 25/50 red	835253	1,950	4.03 kg	69

## Drywall, ring shank nails with full head

Dimension	Item no.	Pcs/box	Weight	Box/pallet
■ ZE 25/35	835135	2,600	3.52 kg	69
■ ZE 25/45	835145	1,950	3.39 kg	69

\* Only fits Duo-Fast CNP 75



All TJEP nails for bearing structures manufactured after 1 August 2010 are CE-marked and meet the requirements of Eurocode 5 and standard 14592.

■ Bright ■ Galv. ■ Galv., 12μ ■ HDG ■ Stainless

## TJEP PC 66



Also for CN nails  
(see page 29)

Only 2 kg!

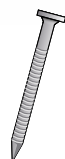

15°  
L: 32 - 65 mm  
Ø: 2,5 mm

PC nails, p. 27  
CN nails, p. 29

- 1 Single shot or bump fire
- 2 Adjustable air exhaust
- 3 Belt hook
- 4 Adjustable depth control
- 5 No-mark pad
- 6 Rubber safety cap

### Specifications

Item no.	100055
EAN no.	5702551000557
Nail length	38 - 65 mm
Air consumption per cycle	2.3 litres
Size (LxWxH)	268 x 128 x 306 mm
Weight	2.05 kg

### Accessories

Description	Item no.
Air tool lube X-1R 100 ml	106229

### Used for

outside siding, panelling, pallets, boarding

## TJEP PC 90



Also for CN nails  
(see page 29)

Only 3 kg!

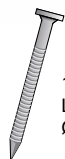

15°  
L: 45 - 90 mm  
Ø: 2.5 - 3.1 mm

PC nails, p. 27  
CN nails, p. 29

- 1 Single shot or bump fire
- 2 Adjustable magazine bottom
- 3 Adjustable depth control
- 4 No-mark pad
- 5 Belt hook
- 6 Rubber safety cap

### Specifications

Item no.	100057
EAN no.	5702551000571
Nail length	45 - 90 mm
Air consumption per cycle	2.9 litres
Size (LxWxH)	311 x 132 x 357 mm
Weight	3.00 kg

### Accessories

Description	Item no.
Air tool lube X-1R 100 ml	106229

### Used for

outside siding, panelling, pallets, boarding, decking

# TJEP PC nails



## PC nails fit

<b>TJEP</b>	PC 65, PC 66, PC 90
<b>MAX</b>	CN 565, HN 90, HN 75, HN 65
<b>Haubold</b>	RCN 90B, RCN 65
<b>Senco</b>	SCN 49, SCN 65, SCN 75

## Ring shank nails with full head

Dimension	Item no.	Pcs/box	Weight	Box/pallet
■ PC 25/38	839038	3,200	5.46 kg	48
■ PC 25/50	839051	2,400	5.16 kg	48
■ PC 25/65	839065	1,600	4.44 kg	48
■ PC 28/65	839066	1,600	5.52 kg	48
■ PC 28/75	839075	1,600	6.35 kg	48
■ PC 28/90	839090	1,600	7.42 kg	48

## Ring shank nails, A4 stainless, flat head

Dimension	Item no.	Pcs/box	Weight	Box/pallet
■ PC 25/51	839451	2,400	4.80 kg	48
■ PC 25/66	839466	1,600	4.14 kg	48
■ PC 25/76	839476	1,600	4.75 kg	48

## Ring shank nails, A4 stainless, lens head

Dimension	Item no.	Pcs/box	Weight	Box/pallet
■ PC 25/50*	839450	2,400	4.80 kg	48
■ PC 25/65*	839465	1,600	4.14 kg	48
■ PC 25/75*	839475	1,600	4.75 kg	48

\* Do not fit PC 90



All TJEP nails for bearing structures manufactured after 1 August 2010 are CE-marked and meet the requirements of Eurocode 5 and standard 14592.

■ Bright ■ Galv. ■ Galv., 12μ ■ HDG ■ Stainless

## TJEP CN 57

## TJEP CN 70

Industrial nailers



15°  
L: 25 - 57 mm  
Ø: 2.1 - 2.3 mm

CN nails, p. 29

- 1 Adjustable air exhaust
- 2 Robust magazine
- 3 Non-slip grip / less hand fatigue
- 4 300 - 350 shots before reload
- 5 Rubber safety cap

### Specifications

Item no.	100046
EAN no.	5702551000465
Nail length	25 - 57 mm
Air consumption per cycle	2.8 litres
Size (LxWxH)	302 x 132 x 285 mm
Weight	2.50 kg

### Accessories

Description	Item no.
Air tool lube X-1R 100 ml	106229

### Used for

pallets, packaging



Suitable for mounting on automated fastening systems



15°  
L: 45 - 70 mm  
Ø: 2.3 - 2.9 mm

CN nails, p. 29

- 1 Supplied with bump fire trigger
- 2 Robust magazine
- 3 Non-slip grip / less hand fatigue
- 4 225 - 300 shots before reload
- 5 Rubber safety cap

### Specifications

Item no.	100048
EAN no.	5702551000489
Nail length	45 - 70 mm
Air consumption per cycle	2.9 litres
Size (LxWxH)	307 x 131 x 317 mm
Weight	3.60 kg

### Accessories

Description	Item no.	Weight
Air tool lube X-1R 100 ml	106229	5157851

### Used for

pallets, packaging





## TJEP CN 100 EPAL

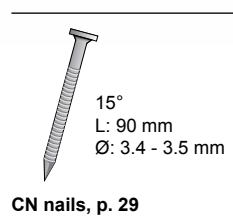

- 1 Downwards exhaust
- 2 Robust magazine
- 3 Well-balanced with string-relief
- 4 Silencer
- 5 Non-slip grip / less hand fatigue
- 6 Rubber safety cap

### Specifications

Item no.	100357
EAN no.	5702551003572
Nail length	90 mm
Air consumption per cycle	3.0 litres
Size (LxWxH)	339 x 154 x 418 mm
Weight	5.25 kg

### Accessories

Description	Item no.
Air tool lube X-1R 100 ml	106229

Used for  
pallets

## TJEP CN nails



Always approx. 50 dimensions  
of CN nails in stock  
Diameter 1.8 - 3.4 mm / length 19 - 100 mm

### CN nails fit

<b>TJEP</b>	CN 57, CN 70, CN 100 EPAL, TS65, PC 66, PC 90
<b>Paslode</b>	P-350C, P-275C, CNW70, CNW90
<b>Senco</b>	SCN60, SCN65, SCN57, SCN64
<b>MAX</b>	MCN 55, CN 565, CN 70, MCN 80, MCN 890, HN 90, HN 75
<b>Haubold</b>	RCN 90B, RCN 65

### Examples of CN ring shank nails with full head

Dimension	Item no.	Pcs/box	Weight	Box/pallet
■ CN 21/30	112333	16,800	15.23 kg	40
■ CN 21/35	112336	14,700	15.68 kg	40
■ CN 21/40	112340	12,600	15.16 kg	40
■ CN 21/45	112346	12,600	17.46 kg	40
■ CN 21/50	112353	10,500	15.73 kg	40
■ CN 25/50	112352	9,000	19.44 kg	40
■ CN 25/65	112367	7,200	19.08 kg	40
■ CN 28/70	112371	6,000	21.66 kg	40
■ CN 28/75	112375	4,500	17.33 kg	45
■ CN 31/90	112391	4,000	21.66 kg	40
■ CN 34/90	112399	3,000	18.40 kg	40

■ Bright ■ Galv. ■ Galv., 12µ ■ HDG ■ Stainless

**Did you know ...**  
**... that [www.tjep.co.uk](http://www.tjep.co.uk) is**  
**optimised for PC's, mobile**  
**phones and tablets (iPad)?**



Scan the code and visit  
[www.tjep.co.uk](http://www.tjep.co.uk) with your  
mobile phone or tablet (iPad)





# Haften Nailers

## Nailers

TJEP HA-35 GAS 2G .....	32
TJEP PC 66 Haften .....	33

## Fasteners

TJEP HA nails.....	32
TJEP PC nails .....	33

## TJEP HA-35 GAS 2G

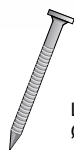

L: 22 - 35 mm  
Ø: 2.8 mm

HA nails, p. 32

- 1 Smooth no-mark nose
- 2 Adjustable depth control
- 3 Rubber pad – anti-skid
- 4 Belt hook
- 5 Non-slip grip
- 6 Top load

## Specifications

Item no.	100828
EAN no.	5702551008287
Nail length	22 - 35 mm
Size (LxWxH)	327 x 137 x 309 mm
Weight incl. battery	2.26 kg

Supplied with 2 batteries and charger in plastic case.

## Accessories

Description	Item no.
TJEP fuel cell, 78 mm, yellow ring	100851
TJEP battery, 1.65 Ah NiMh	100842
TJEP charger for TJEP battery, 1.65 Ah NiMh	100840

## Used for

haften, tin roofs, zinc sheathing, covering

## TJEP HA haften nails



## HA haften nails fit

TJEP	HA 35 GAS 2G
Paslode	IM 200 A/35 HAFTE

## Stainless A2

Dimension	Item no.	Pcs/box	Weight	Box/carton
HA 28/25	839802	900	1.25 kg	10



■ Bright  
 ■ Galv.  
 ■ Galv., 12µ  
 ■ HDG  
 ■ Stainless



## TJEP PC 66 Haften



15°  
L: 25 - 65 mm  
Ø: 2.5 mm

PC nails, p. 27 and 33

- 1 Single shot or bump fire
- 2 Adjustable air exhaust
- 3 Belt hook
- 4 Adjustable depth control
- 5 No-mar pad
- 6 Rubber safety cap

### Specifications

Item no.	100056
EAN no.	5702551000564
Nail length	25 - 65 mm
Air consumption per cycle	2.3 litres
Size (LxWxH)	268 x 128 x 306 mm
Weight	2.05 kg

### Accessories

Description	Item no.
Air tool lube X-1R 100 ml	106229

### Used for

haften, tin roofs, zinc sheathing, covering

## TJEP PC haften nails



### PC nails fit

<b>TJEP</b>	PC 66 Haften
<b>MAX</b>	CN 450G, CN 351R
<b>Haubold</b>	RCN 50 S/W

### Ring shank nails with full head

	Dimension	Item no.	Pcs/box	Weight	Box/pallet
■	PC 25/25	839804	3,600	4.70 kg	100
■	PC 25/25	839806	3,600	4.57 kg	100

Also for PC nails up to 65 mm  
(see page 27)

■ Bright ■ Galv. ■ Galv., 12µ ■ HDG ■ Stainless

**Did you know ...  
... that at [www.tjep.eu](http://www.tjep.eu)  
you can see the latest  
news and products?**



Scan the code and visit  
[www.tjep.co.uk](http://www.tjep.co.uk) with your  
mobile phone or tablet (iPad)



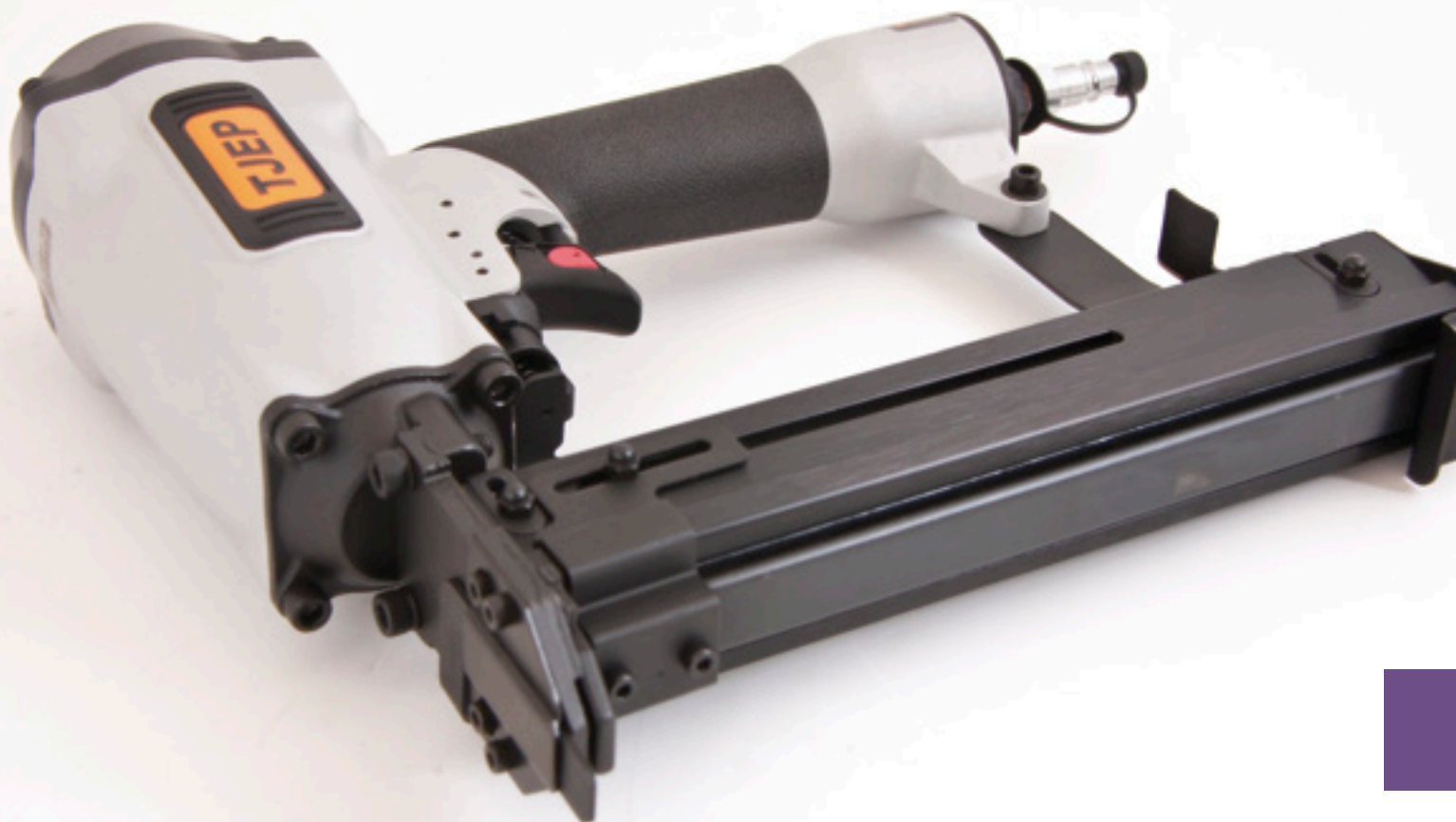

# Corrugated Nailers

## Nailers

TJEP CO-15 ..... 36

## Fasteners

TJEP CO nails ..... 36

# TJEP CO-15



# TJEP CO corrugated nails



- 1 Robust
- 2 Powerful
- 3 Adjustable air exhaust
- 4 Single shot or bump fire

### CO corrugated nails fit

TJEP	CO-15
Senco	F 45C

### CO corrugated nails

Dimension	Item no.	Pcs/box	Weight	Box/pallet
CO 25/13	839808	8,400	11.80 kg	90

### Specifications

Item no.	100332
EAN no.	5702551003329
Nail length	13 mm
Air consumption per cycle	1.4 litres
Size (LxWxH)	301 x 82 x 283 mm
Weight	2.41 kg

### Accessories

Description	Item no.
Air tool lube X-1R 100 ml	106229

### Used for

corner jointing, rafting

Bright	Galv.	Galv., 12µ	HDG	Stainless
--------	-------	------------	-----	-----------





# Concrete Nailers

## Nailers

TJEP CP-40 GAS 2G .....	38
TJEP CP-40.....	39

## Fasteners

TJEP CP concrete pins .....	39
-----------------------------	----

TJEP ST-15/50 finish nailer  
for concrete, see page 53

# TJEP CP-40 GAS 2G

**New 2013 model**

- New handle, better support
- New air filter, less maintenance
- New safety bracket, improved trigger
- Magnetic ring on nose for easier mounting

Introduced in spring 2013

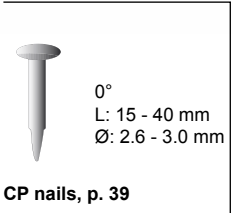
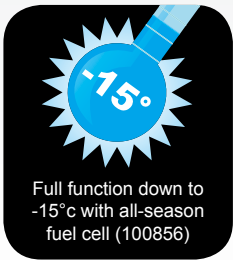

- 1 Adjustable depth control
- 2 Support bracket
- 3 Non-slip grip
- 4 Rafter/belt hook
- 5 Rubber cap protection
- 6 Quick open of nose if nail trapped

CP nails, p. 39

**Specifications**

Item no.	100826
EAN no.	5702551008263
Nail length	15 - 40 mm
Size (LxWxH)	458 x 138 x 373 mm
Weight incl. battery	3.80 kg

Supplied with 2 batteries and charger in plastic case.

**Accessories**

Description	Item no.
TJEP fuel cell, 165 mm, orange ring	100853
TJEP all-season fuel cell, 165 mm, red ring (-15°C)	100856
TJEP battery, 1.65 Ah NiMh	100842
TJEP charger for TJEP Battery, 1.65 Ah NiMh	100840

**Used for**

concrete, drywall steel rails



## TJEP CP-40

**NEW**Introduced in  
spring 20130°  
L: 15 - 40 mm  
Ø: 2.6 - 3.0 mm

CP nails, p. 39

- 1 Adjustable depth control
- 2 Support bracket
- 3 Non-slip grip
- 4 Rafter/belt hook
- 5 Quick open of nose if nail trapped

**Specifications**

Item no.	100362
EAN no.	5702551003626
Nail length	15 - 40 mm
Air consumption per cycle	3.0 litres
Size (LxWxH)	437 x 120 x 320 mm
Weight	3.40 kg

**Accessories**

Description	Item no.
Air tool lube X-1R 100 ml	106229

**Used for**

concrete, drywall steel rails

## TJEP CP concrete pins

**CP concrete pins fit**

<b>TJEP</b>	CP-40 GAS, CP-40
<b>Spit</b>	Pulsa 700 P, Pulsa 700 E, Pulsa 1000
<b>Senco</b>	SPA 40

**Smooth shank concrete pins for concrete**

Dimension	Item no.	Pcs/box	Weight	Box/carton
■ CP 26/16	839116	500	0.75 kg	10
■ CP 26/20	839120	500	0.85 kg	10
■ CP 26/25	839125	500	0.95 kg	10
■ CP 26/30	839130	500	1.06 kg	10
■ CP 26/35	839136	500	1.20 kg	10
■ CP 26/40	839140	500	1.35 kg	10

**Steppoint concrete pins for concrete and steel**

Dimension	Item no.	Pcs/box	Weight	Box/carton
■ CP 30/15	839915	500	0.75 kg	10
■ CP 30/20	839920	500	0.84 kg	10
■ CP 30/25	839925	500	0.95 kg	10
■ CP 30/30	839930	500	1.06 kg	10
■ CP 30/35	839935	500	1.20 kg	10

■ Galv.    ■ Mech. galv.

**Did you know ...  
... that at [www.tjep.eu](http://www.tjep.eu)  
you can find technical  
data and manuals for  
the various nailers?**



Scan the code and visit  
[www.tjep.co.uk](http://www.tjep.co.uk) with your  
mobile phone or tablet (iPad)







# Brad and Finish Nailers

## Nailers

TJEP TF-18/40 .....	42
TJEP TF-18/45 .....	42
TJEP F-18/50 .....	43
TJEP TF-18/50 GAS 2G .....	43
TJEP TF-18/55 .....	44
TJEP VD-18/50 .....	45
TJEP VF-16/64 GAS 2G .....	46
TJEP TF-16/38 .....	47
TJEP F-16/50 .....	47
TJEP TF-16/50F .....	48
TJEP TF-16/63B .....	48
TJEP TF-16/64 GAS 2G .....	49
TJEP AB-15 .....	50
TJEP AB-15/50 .....	50
TJEP AB-15/64 GAS .....	51
TJEP VD-15/50 .....	52
TJEP ST-15/50 .....	53
TJEP TT-65 .....	54

## Fasteners

TJEP TF-18 .....	44
TJEP VD-18 .....	45
TJEP VF-16 .....	46
TJEP TF-16 .....	49
TJEP AB-15 .....	51
TJEP VD-15 .....	52
TJEP ST-50 .....	53
TJEP TT .....	54

## TJEP TF-18/40



For mounting 'hidden' glazing beads

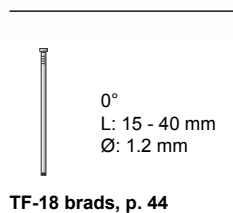

TF-18 brads, p. 44

- 1 Rubber rollers protect the glass
- 2 Adjustable angle
- 3 Special safety bracket
- 4 Precise insertion into groove
- 5 Adjustable depth control
- 6 Empty magazine indicator

### Specifications

Item no.	100440
EAN no.	5702551004401
Nail length	15, 19, 25, 30, 35, 38, 40 mm
Air consumption per cycle	1.0 litres
Size (LxWxH)	285 x 68 x 222 mm
Weight	1.28 kg

### Accessories

Description	Item no.
Air tool lube X-1R 100 ml	106229

### Used for

glazing beads

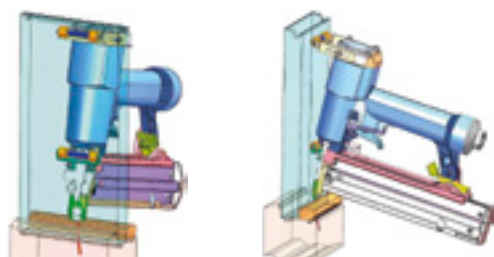

## TJEP TF-18/45



Only weighs 1.1 kg!

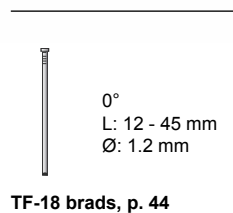

TF-18 brads, p. 44

- 1 Safety bracket integrated in nose
- 2 No-mark pad
- 3 Exhaust in bottom cover
- 4 Adjustable depth control
- 5 Belt hook
- 6 Dry fire lock-out

### Specifications

Item no.	100421
EAN no.	5702551004210
Nail length	12, 15, 19, 25, 32, 38, 45 mm
Air consumption per cycle	0.5 litres
Size (LxWxH)	227 x 53 x 227 mm
Weight	1.10 kg

### Accessories

Description	Item no.
Air tool lube X-1R 100 ml	106229

### Used for

glazing beads, secret fixing, panelling, cabinets, displays



## TJEP F-18/50



## TJEP TF-18/50 GAS 2G

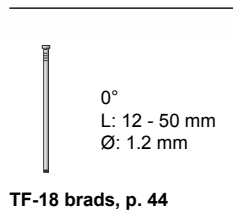

- 1 Adjustable air exhaust
- 2 Single shot or bump fire
- 3 No-mark pad
- 4 Adjustable depth control
- 5 Empty magazine indicator

TF-18 brads, p. 44

### Specifications

Item no.	100419
EAN no.	5702551004197
Nail length	15, 19, 25, 32, 38, 40, 50 mm
Air consumption per cycle	1.0 litres
Size (LxWxH)	250 x 65 x 231 mm
Weight	1.30 kg

### Accessories

Description	Item no.
Air tool lube X-1R 100 ml	106229

### Used for

glazing beads, secret fixing, panelling, cabinets, displays

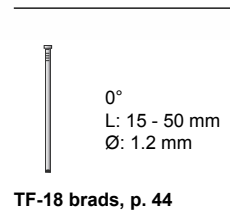

- 1 Quick open of nose if nail trapped
- 2 Adjustable depth control
- 3 No-mark pad
- 4 Rear two-step loading
- 5 Belt hook
- 6 Empty magazine indicator

TF-18 brads, p. 44

### Specifications

Item no.	100811
EAN no.	5702551008119
Nail length	15, 19, 25, 32, 38, 40, 45, 50 mm
Size (LxWxH)	315 x 86 x 274 mm
Weight incl. battery	2.13 kg

Supplied with soft no-mark nose, 2 batteries and charger in plastic case.

### Accessories

Description	Item no.
TJEP fuel cell, 78 mm, yellow ring	100851
TJEP battery, 1.65 Ah NiMH	100842
TJEP charger for TJEP battery, 1.65 Ah NiMH	100840

### Used for

glazing beads, secret fixing, panelling, cabinets, display

# TJEP TF-18/55

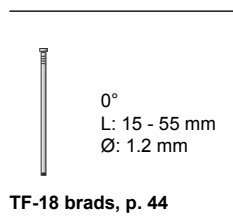

- 1 Safety bracket integrated in nose
- 2 Adjustable air exhaust
- 3 Adjustable depth control
- 4 Integrated no-mark pad
- 5 Belt hook
- 6 Dry fire lock-out

### Specifications

Item no.	100428
EAN no.	5702551004289
Nail length	15 - 55 mm
Air consumption per cycle	1.0 litres
Size (LxWxH)	262 x 68 x 262 mm
Weight	1.50 kg

### Accessories

Description	Item no.
Air tool lube X-1R 100 ml	106229

### Used for

glazing beads, secret fixing, panelling, cabinets, displays

# TJEP TF-18 brads, 0°



### TF-18 brads fit

<b>TJEP</b>	TF-18/45, F-18/50, TF-18/50 GAS, 90/F-18, TF-18/40
<b>Paslode</b>	TFN 1835/F-18, TFN 1850/F-18, ZE 114 BP, IMP 50 F-18, IMP200 F-18, FNS1850
<b>Duo-Fast</b>	K4440
<b>Senco</b>	SCP 20, FP 18, CF 25
<b>Dewalt</b>	D51238K
<b>MAX</b>	201, 255, NF221/F-18

Dimension	Item no.	Pcs/box	Weight	Box/carton
TF-18, 12 mm	842012	5,000	0.56 kg	20
TF-18, 15 mm	842015	5,000	0.67 kg	20
TF-18, 19 mm	842019	5,000	0.90 kg	16
TF-18, 22 mm	842022	5,000	0.97 kg	16
TF-18, 25 mm	842025	5,000	1.10 kg	16
TF-18, 30 mm	842030	5,000	1.30 kg	12
TF-18, 32 mm	842032	5,000	1.44 kg	12
TF-18, 35 mm	842035	5,000	1.57 kg	8
TF-18, 38 mm	842038	5,000	1.70 kg	8
TF-18, 40 mm	842040	5,000	1.68 kg	8
TF-18, 45 mm	842045	5,000	1.70 kg	8
TF-18, 50 mm	842050	5,000	2.11 kg	8

### Stainless A4

Dimension	Item no.	Pcs/box	Weight	Box/carton
TF-18, 15 mm	842016	5,000	0.80 kg	20
TF-18, 19 mm	842021	5,000	0.90 kg	16
TF-18, 22 mm	842023	5,000	1.00 kg	16
TF-18, 25 mm	842026	5,000	1.10 kg	16
TF-18, 30 mm	842031	5,000	1.33 kg	12
TF-18, 32 mm	842033	5,000	1.44 kg	12
TF-18, 38mm	842039	5,000	1.60 kg	8

■ Bright 
 ■ Galv. 
 ■ Galv., 12µ 
 ■ HDG 
 ■ Stainless



# TJEP VD-18/50



1.2 mm brads

1.2 mm brads

# TJEP VD-18 brads, 26°

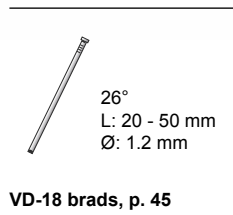

- 1 Safety bracket integrated in nose
- 2 Belt hook
- 3 Adjustable air exhaust
- 4 No-mark pad
- 5 Dry fire lock-out
- 6 Easy access in narrow corners

### Specifications

Item no.	100417
EAN no.	5702551004173
Nail length	20 - 50 mm
Air consumption per cycle	1.0 litres
Size (LxWxH)	276 x 68 x 261 mm
Weight	1.38 kg

### Accessories

Description	Item no.
Air tool lube X-1R 100 ml	106229

### Used for

glazing beads, secret fixing, panelling, cabinets, displays

### VD-18 brads fit

	TJEP Paslode	VD-18/50 FN 1850 A26			
Dimension	Item no.	Pcs/box	Weight	Box/carton	
VD-18, 20mm	842620	5,000	0.93 kg	15	
VD-18, 25mm	842625	5,000	1.10 kg	15	
VD-18, 32mm	842632	5,000	1.50 kg	10	
VD-18, 38mm	842638	5,000	1.70 kg	10	
VD-18, 45mm	842645	5,000	2.06 kg	8	
VD-18, 50mm	842650	5,000	2.25 kg	8	

■ Bright  
 ■ Galv.  
 ■ Galv., 12µ  
 ■ HDG  
 ■ Stainless

# TJEP VF-16/64 GAS 2G

# TJEP VF-16 finish nails, 20°



1.6 mm finish nails

1.6 mm finish nails

**New 2012 model**

- New handle, better support
- New air filter, less maintenance
- New safety bracket, improved trigger

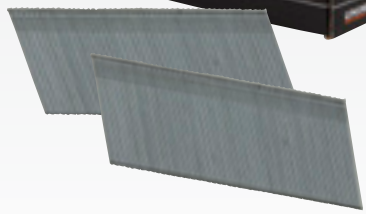

20°  
L: 32 - 63 mm  
Ø: 1.6 mm

VF-16 finish nails, s. 46

- 1 Quick open of nose if nail trapped
- 2 Adjustable depth control
- 3 Rear two-step loading
- 4 Belt hook
- 5 No-mark pad

### VF-16 finish nails fit

<b>TJEP</b>	VF-16/64 GAS
<b>Paslode</b>	FN 16 A65, IMP 250A, IM 65 ABF 16
<b>Dewalt</b>	DC618KB, DC618KN

### Specifications

<b>Item no.</b>	100819
<b>EAN no.</b>	5702551008195
<b>Nail length</b>	32 - 63 mm
<b>Size (LxWxH)</b>	332 x 86 x 275 mm
<b>Weight incl. battery</b>	2.22 kg

Supplied with 2 batteries and charger in plastic case.

### Accessories

Description	Item no.
TJEP fuel cell, 78 mm, yellow ring	100851
TJEP battery, 1.65 Ah NiMh	100842
TJEP charger for TJEP battery, 1.65 Ah NiMh	100840

### Used for

wood ceiling, coving, dado, skirting

Dimension	Item no.	Pcs/box	Weight	Box/carton
VF-16, 32mm	842432	2,000	1.08 kg	12
VF-16, 38mm	842438	2,000	1.28 kg	12
VF-16, 45mm	842445	2,000	1.48 kg	12
VF-16, 51mm	842451	2,000	1.66 kg	8
VF-16, 63mm	842463	2,000	2.06 kg	8

### A4 Stainless

Dimension	Item no.	Pcs/box	Weight	Box/carton
VF-16, 32mm	842433	2,000	1.08 kg	12
VF-16, 38mm	842439	2,000	1.28 kg	12
VF-16, 51mm	842452	2,000	1.66 kg	8

■ Bright  
 ■ Galv.  
 ■ Galv., 12µ  
 ■ HDG  
 ■ Stainless

# TJEP TF-16/38

1.6 mm finish nails



Only weighs 1.1 kg!



0°  
L: 19 - 38 mm  
Ø: 1.6 mm

TF-16 finish nails, s. 49

- 1 Safety bracket integrated in nose
- 2 Dry fire lock-out
- 3 No-mark pad
- 4 Belt hook
- 5 Exhaust in bottom cover
- 6 Adjustable depth control

### Specifications

Item no.	100412
EAN no.	5702551004128
Nail length	19, 25, 32, 38 mm
Air consumption per cycle	0.5 litres
Size (LxWxH)	227 x 53 x 227 mm
Weight	1.10 kg

### Accessories

Description	Item no.
Air tool lube X-1R 100 ml	106229

### Used for

wood ceiling, coving, dado, skirting, glazing beads

# TJEP F-16/50

1.6 mm finish nails



0°  
L: 15 - 50 mm  
Ø: 1.6 mm

TF-16 finish nails, s. 49

- 1 Empty magazine indicator
- 2 Adjustable air exhaust
- 3 No-mark pad
- 4 Adjustable depth control
- 5 Quick open of nose if nail trapped
- 6 Single shot or bump fire

### Specifications

Item no.	100416
Weight	5675043
EAN no.	5702551004166
Nail length	15, 19, 25, 32, 38, 45, 50 mm
Air consumption per cycle	1.0 litres
Size (LxWxH)	246 x 62 x 247 mm
Weight	1.46 kg

### Accessories

Description	Item no.
Air tool lube X-1R 100 ml	106229

### Used for

wood ceiling, coving, dado, skirting, glazing beads

## TJEP TF-16/50F

1.6 mm finish nails

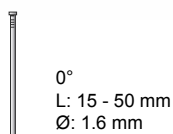

TF-16 finish nails, s. 49

- 1 Safety bracket integrated in nose
- 2 Silencer exhaust
- 3 Adjustable air exhaust
- 4 Adjustable depth control
- 5 Dry fire lock-out
- 6 No-mark pad

### Specifications

Item no.	100413
EAN no.	5702551004135
Nail length	15, 19, 25, 32, 38, 45, 50 mm
Air consumption per cycle	1.0 litres
Size (LxWxH)	262 x 68 x 262 mm
Weight	1.40 kg

### Accessories

Description	Item no.
Air tool lube X-1R 100 ml	106229

### Used for

wood ceiling, coving, dado, skirting, glazing beads

## TJEP TF-16/63B

1.6 mm finish nails

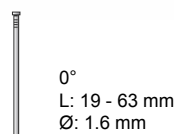

TF-16 finish nails, s. 49

- 1 Dry fire lock-out
- 2 Adjustable air exhaust
- 3 Adjustable depth control
- 4 Non-slip grip
- 5 Two no-mark pads (diff. lengths)
- 6 Safety bracket integrated in nose

### Specifications

Item no.	100467
EAN no.	5702551004678
Nail length	19, 25, 32, 38, 45, 50, 63 mm
Air consumption per cycle	1.4 litres
Size (LxWxH)	279 x 68 x 283 mm
Weight	1.50 kg

### Accessories

Description	Item no.
Air tool lube X-1R 100 ml	106229

### Used for

wood ceiling, coving, dado, skirting, glazing beads



# TJEP TF-16/64 GAS 2G

# TJEP TF-16 finish nails, 0°



1.6 mm finish nails

1.6 mm finish nails

**New 2012 model**

- New handle, better support
- New air filter, less maintenance
- New safety bracket, improved trigger



0°  
L: 18 - 63 mm  
Ø: 1.6 mm

TF-16 finish nails, s. 49

- 1 Quick open of nose if nail trapped
- 2 No-mark pad
- 3 Belt hook
- 4 Rear two-step loading
- 5 Adjustable depth control

### TF-16 finish nails fit

<b>TJEP</b>	TF-16/64 GAS, TF-16/50F, TF-16/63B, F-16/50, TF-16/38
<b>Paslode</b>	FN 1665.1, FN 1665, 3250 F-16, FN1650, Impulse IMP 65 F-16, Impulse 250CT
<b>Senco</b>	SLP 20, FP 32, CF 32, S200 SM
<b>Dewalt</b>	D51257K, DC 616 KB

### Specifications

<b>Item no.</b>	100816
<b>EAN no.</b>	5702551008164
<b>Nail length</b>	18 - 63 mm
<b>Size (LxWxH)</b>	315 x 86 x 274 mm
<b>Weight incl. battery</b>	2.13 kg

Supplied with 2 batteries and charger in plastic case.

### Accessories

Description	Item no.
TJEP fuel cell, 78 mm, yellow ring	100851
TJEP battery, 1.65 Ah NiMh	100842
TJEP charger for TJEP battery, 1.65 Ah NiMh	100840

### Used for

wood ceiling, coving, dado, skirting

Dimension	Item no.	Pcs/box	Weight	Box/carton
TF-16, 19 mm	842119	5,000	1.52 kg	8
TF-16, 25 mm	842125	5,000	2.06 kg	8
TF-16, 32 mm	842132	5,000	2.56 kg	6
TF-16, 38 mm	842138	2,500	1.49 kg	8
TF-16, 45 mm	842145	2,500	1.97 kg	8
TF-16, 50 mm	842150	2,500	2.18 kg	8
TF-16, 63 mm	842163	2,500	2.38 kg	6

### Stainless A4

Dimension	Item no.	Pcs/box	Weight	Box/carton
TF-16, 18 mm	842118	5,000	1.50 kg	8
TF-16, 22 mm	842122	5,000	1.74 kg	8
TF-16, 25 mm	842126	5,000	2.06 kg	8
TF-16, 32 mm	842133	5,000	2.56 kg	6
TF-16, 38 mm	842139	2,500	1.49 kg	8
TF-16, 50 mm	842151	2,500	1.97 kg	8

■ Bright  
 ■ Galv.  
 ■ Galv., 12µ  
 ■ HDG  
 ■ Stainless

## TJEP AB-15



Compact and light  
for DA brads



34°  
L: 25 - 64 mm  
Ø: 1.8 mm

AB-15 finish nails, s. 51

- 1 Adjustable air exhaust
- 2 Rear two-step loading
- 3 No-mark pad
- 4 Quick open of nose if nail trapped
- 5 Non-slip grip

### Specifications

Item no.	100414
EAN no.	5702551004142
Nail length	25 - 64 mm
Air consumption per cycle	1.4 litres
Size (LxWxH)	349 x 85 x 314 mm
Weight	1.95 kg

### Accessories

Description	Item no.
Glass protection plate	861062
Air tool lube X-1R 100 ml	106229

### Used for

wood ceiling, coving, dado, skirting, glazing beads

## TJEP AB-15/50



Compact and light  
- only 1.5 kg

For DA brads



34°  
L: 25 - 50 mm  
Ø: 1.8 mm

AB-15 finish nails, s. 51

- 1 Adjustable depth control
- 2 Safety bracket integrated in nose
- 3 No-mark pad
- 4 Exhaust in bottom cover
- 5 Non-slip grip
- 6 Rear two-step loading

### Specifications

Item no.	100422
EAN no.	5702551004227
Nail length	25 - 50 mm
Air consumption per cycle	1.0 litres
Size (LxWxH)	305 x 73 x 258 mm
Weight	1.50 kg

### Accessories

Description	Item no.
Glass protection plate	870284
Air tool lube X-1R 100 ml	106229

### Used for

rustic ceiling, coving, skirting, covering, glazing beads

# TJEP AB-15/64 GAS

1.8 mm finish nails

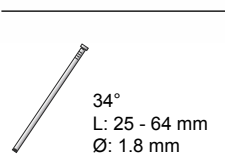

AB-15 finish nails, s. 51

- 1 No-mark pad
- 2 Adjustable depth control
- 3 Quick open of nose if nail trapped
- 4 Non-slip grip
- 5 Belt hook
- 6 Rear two-step loading

## Specifications

Item no.	100821
EAN no.	5702551008218
Nail length	25 - 64 mm
Size (LxWxH)	332 x 126 x 310 mm
Weight incl. battery	2.33 kg

Supplied with additional no-mark nose for siding, 2 batteries and charger in plastic case.

## Accessories

Description	Item no.
TJEP fuel cell, 78 mm, yellow ring	100851
TJEP battery, 1.65 Ah NiMh	100842
TJEP charger for TJEP battery, 1.65 Ah NiMh	100840

## Used for

wood ceiling, panels, frames, glazing beads

# TJEP AB-15 finish nails, 34°

1.8 mm finish nails

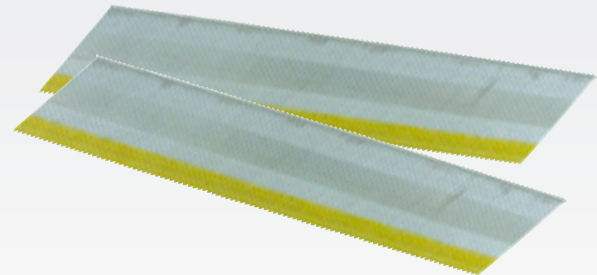

## AB-15 finish nails (DA brads) fit

Brand	Model
TJEP	AB-15/64 GAS, AB-15/50, AB-15
Paslode	3250 AB-15, FN1565A34
Senco	SFN 30, FP 42XP, FP 35, GT 65 DA GAS
Dewalt	D51276K

Dimension	Item no.	Pcs/box	Weight	Box/carton
AB-15, 25 mm	842525	4,000	2.10 kg	5
AB-15, 32 mm	842532	4,000	2.69 kg	5
AB-15, 38 mm	842538	4,000	3.14 kg	5
AB-15, 45 mm	842545	4,000	3.78 kg	4
AB-15, 50 mm	842550	4,000	4.18 kg	4
AB-15, 64 mm	842564	4,000	5.37 kg	3

## Stainless A4, lens head

Dimension	Item no.	Pcs/box	Weight	Box/carton
AB-15, 25 mm	842526	4,000	2.10 kg	5
AB-15, 32 mm	842533	4,000	2.69 kg	5
AB-15, 38 mm	842539	4,000	3.14 kg	5
AB-15, 50 mm	842551	4,000	3.60 kg	4

■ Bright 
 ■ Galv. 
 ■ Galv., 12µ 
 ■ HDG 
 ■ Stainless

# TJEP VD-15/50



1.8 mm finish nails

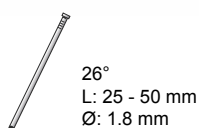

VD-15 finish nails, s. 52

- 1 Safety bracket integrated in nose
- 2 Adjustable air exhaust
- 3 Dry fire lock-out
- 4 No-mark pad
- 5 Adjustable depth control

### Specifications

Item no.	100415
EAN no.	5702551004159
Nail length	25 - 50 mm
Air consumption per cycle	1.0 litres
Size (LxWxH)	276 x 68 x 261 mm
Weight	1.38 kg

### Accessories

Description	Item no.
Air tool lube X-1R 100 ml	106229

### Used for

wood ceiling, coving, dado, skirting, architraves, glazing beads

# TJEP VD-15 finish nails, 26°

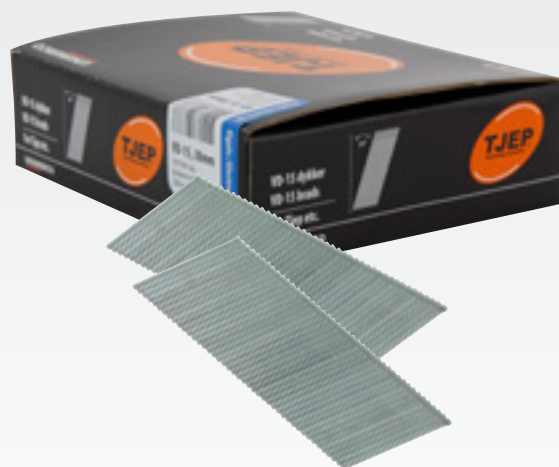

1.8 mm finish nails

### VD-15 finish nails fit

TJEP Paslode	VD-15/50 FN1550A26			
Dimension	Item no.	Pcs/box	Weight	Box/carton
VD-15, 25mm	842725	3,000	1.78 kg	6
VD-15, 32mm	842732	3,000	2.27 kg	6
VD-15, 38mm	842738	3,000	2.40 kg	6
VD-15, 45mm	842745	3,000	3.05 kg	4
VD-15, 50mm	842750	3,000	3.45 kg	4

### Stainless A4

Dimension	Item no.	Pcs/box	Weight	Box/carton
VD-15, 25mm	842726	3,000	1.78 kg	6
VD-15, 32mm	842733	3,000	2.27 kg	6
VD-15, 38mm	842739	3,000	2.40 kg	6
VD-15, 50mm	842751	3,000	3.45 kg	4

■ Bright  
 ■ Galv.  
 ■ Galv., 12µ  
 ■ HDG  
 ■ Stainless



# TJEP ST-15/50

1.8 mm finish nails



For bricks and concrete

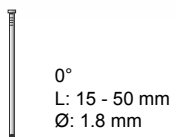

ST-50 finish nails, s. 53

- 1 Safety bracket integrated in nose
- 2 No-mark pad
- 3 Exhaust in bottom cover
- 4 Adjustable depth control
- 5 Non-slip grip
- 6 Dry fire lock-out

### Specifications

Item no.	100426
EAN no.	5702551004265
Nail length	15 - 50 mm
Air consumption per cycle	1.2 litres
Size (LxWxH)	271 x 73 x 254 mm
Weight	1.50 kg

### Accessories

Description	Item no.
Air tool lube X-1R 100 ml	106229

### Used for

wood ceiling, coving, dado, skirting, architraves, glazing beads



# TJEP ST-50 finish nails, 0°

1.8 mm finish nails



Hardened steel nails for concrete

### ST-50 finish nails fit

TJEP Paslode	ST-15/50, ST-50 FN1650C
--------------	-------------------------

Dimension	Item no.	Pcs/box	Weight	Box/carton
ST-50, 18mm*	842218	3,000	1.07 kg	10
ST-50, 20mm	842220	3,000	1.19 kg	10
ST-50, 25mm	842225	3,000	1.59 kg	10
ST-50, 30mm	842230	3,000	1.79 kg	10
ST-50, 35mm*	842235	1,500	1.06 kg	10
ST-50, 40mm	842240	1,500	1.20 kg	10
ST-50, 50mm	842250	1,500	1.50 kg	10

### Assortment with various lengths

Dimension	Item no.	Pcs/box	Weight	Box/carton
Assortment	111053	2,400	1.33 kg	10

400 pcs. of each length: 15, 20, 25, 30, 40, 50 mm

\* only for TJEP ST-50

- Bright
- Galv.
- Galv., 12µ
- HDG
- Stainless

# TJEP TT-65

2.5 mm finish nails

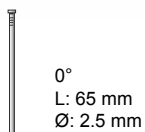

TT finish nails, s. 54

- 1 Adjustable air exhaust
- 2 Dry fire lock-out
- 3 Side load
- 4 Extra nose piece for tongue, 45°

### Specifications

Item no.	100471
EAN no.	5702551004715
Nail length	65 mm
Air consumption per cycle	2.8 litres
Size (LxWxH)	318 x 92 x 293 mm
Weight	2.80 kg

### Accessories

Description	Item no.
Air tool lube X-1R 100 ml	106229

**Used for**  
flooring

# TJEP TT finish nails, 0°

2.5 mm finish nails



### TT finish nails fit

TJEP Senco	TT-65 T-nailer			
<b>Dimension</b>	<b>Item no.</b>	<b>Pcs/box</b>	<b>Weight</b>	<b>Box/pallet</b>
■ TT 2.5x65	111065	5,000	12.95 kg	100



■ Bright ■ Galv. ■ Galv., 12µ ■ HDG ■ Stainless

Always follow the directions of the flooring supplier when selecting nails, finish nails or staples for mounting floor boards



# Staplers

## Staplers

TJEP PG-50/14 .....	56
TJEP 80/16 .....	57
TJEP 80/16 auto .....	57
TJEP 90/40 .....	58
TJEP 90/F-18 .....	58
TJEP BE-90/40 .....	59
TJEP BN-90/40 .....	60
TJEP ES-500/40 .....	61
TJEP PZ-16/50 .....	62
TJEP PQZ-64 .....	62
TJEP PQZ-75 GAS 2G .....	63
TJEP MF-14/150 .....	65
TJEP TW-16/38 .....	66

## Fasteners

TJEP PG-50 .....	56
TJEP BE-50 .....	57
TJEP BE-90 .....	60
TJEP ES-500 .....	61
TJEP PZ-16 .....	64
TJEP PQ-15 .....	64
TJEP MF-14 .....	65
TJEP TW-16 .....	66

## TJEP PG-50/14

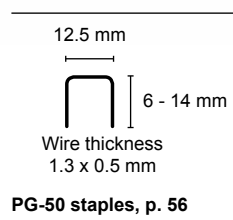

- 1 Adjustable air exhaust
- 2 Bottom load

### Specifications

<b>Item no.</b>	100686
<b>EAN no.</b>	5702551006863
<b>Nail length</b>	6 - 14 mm
<b>Air consumption per cycle</b>	0.3 litres
<b>Size (LxWxH)</b>	225 x 45 x 155 mm
<b>Weight</b>	0.90 kg

### Accessories

Description	Item no.
Air tool lube X-1R 100 ml	106229

### Used for

foil, cardboard, weather strips, vapour barriers, upholstery

## TJEP PG-50 staples



Flat wire staples  
– ideal for foil

### PG-50 staples fit

<b>TJEP Duo-Fast</b>	PG-50/14, DF-50/14 CS 5000
----------------------	-------------------------------

Dimension	Item no.	Pcs/box	Weight	Box/carton
■ PG-50, 6 mm	841506	9,000	1.00 kg	10
■ PG-50, 8 mm	841508	7,000	0.95 kg	10
■ PG-50, 10 mm	841510	5,000	0.78 kg	10
■ PG-50, 12 mm	841512	4,000	0.80 kg	10
■ PG-50, 14 mm	841514	4,000	0.90 kg	10

■ Bright ■ Galv. ■ Galv., 12µ ■ HDG ■ Stainless



# TJEP 80/16

# TJEP BE-80 staples

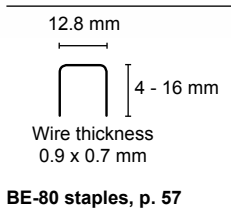
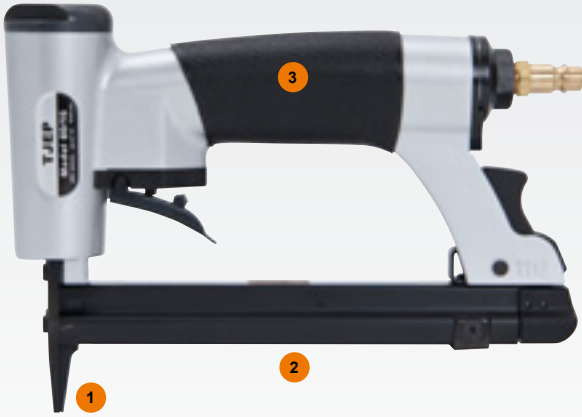

- 1 Long slim nose
- 2 Bottom load
- 3 Non-slip grip

BE-80 staples, p. 57

### Specifications

Item no.	100680
EAN no.	5702551006801
Nail length	4 - 16 mm
Air consumption per cycle	0.3 litres
Size (LxWxH)	152 x 43 x 220 mm
Weight	0.90 kg

### Used for

vapour barriers, plastic, foil, weather strips, cardboard, upholstery

### BE-80 staples fit

TJEP		80/16, 80/16 auto			
Dimension	Item no.	Pcs/box	Weight	Box/carton	
BE-80, 6 mm	841306	12,000	1.20 kg	10	
BE-80, 8 mm	841308	9,000	1.00 kg	10	
BE-80, 10 mm	841310	7,500	1.00 kg	10	
BE-80, 12 mm	841312	6,000	0.90 kg	10	
BE-80, 14 mm	841314	6,000	1.00 kg	10	
BE-80, 16 mm	841316	4,500	0.90 kg	10	

<span style="color: green;">■</span> Bright	<span style="color: blue;">■</span> Galv.	<span style="color: purple;">■</span> Galv., 12µ	<span style="color: red;">■</span> HDG	<span style="color: yellow;">■</span> Stainless
---	---	--	--	---

## TJEP 90/40

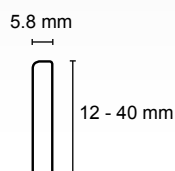

Wire thickness  
1.3 x 1.0 mm

BE-90 staples, p. 60

- 1 Adjustable air exhaust
- 2 Single shot or bump fire
- 3 Bottom load
- 4 Adjustable depth control
- 5 No-mark pad
- 6 Empty magazine indicator

### Specifications

Item no.	100690
EAN no.	5702551006900
Nail length	12 - 40 mm
Air consumption per cycle	1.0 litres
Size (LxWxH)	246 x 62 x 247 mm
Weight	1.46 kg

### Accessories

Description	Item no.
Air tool lube X-1R 100 ml	106229

### Used for

fillets, boarding, frames

## TJEP 90/F-18



5.8 mm Wire thickness  
1.3 x 1.0 mm

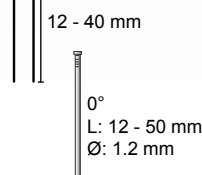

BE-90 staples, p. 60  
TF-18 brads, p. 44

- 1 Adjustable air exhaust
- 2 Single shot or bump fire
- 3 Adjustable depth control
- 4 Empty magazine indicator
- 5 Quick open of nose if nail trapped
- 6 No-mark pad

### Specifications

Item no.	100418
EAN no.	5702551004180
Nail length	12, 16, 19, 25, 30, 32, 40, 50 mm
Air consumption per cycle	1.0 litres
Size (LxWxH)	246 x 62 x 247 mm
Weight	1.46 kg

### Accessories

Description	Item no.
Air tool lube X-1R 100 ml	106229

### Used for

fillets, boarding, frames

# TJEP BE-90/40

**NEW**



Very powerful!

Introduced  
spring 2013

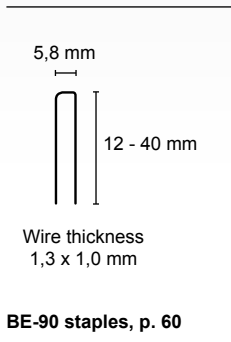

BE-90 staples, p. 60

### Specifications

Item no.	100694
TUN nr.	1606040
EAN no.	5702551006948
Nail length	12 - 40 mm
Airconsumptionpercycle	1,2 litres
Size (LxWxH)	271 x 73 x 243 mm
Weight	1,70 kg

### Accessories

Description	Item no.	TUN nr.
Air tool lube X-1R 100 ml	106229	5157851

### Used for

wood ceiling, fillets, backing, boarding, frames



## TJEP BN-90/40



Ideal for hidden nailing of rustic boards in rear groove

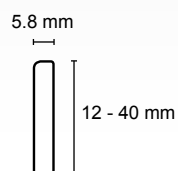

Wire thickness  
1.3 x 1.0 mm

BE-90 staples, p. 60

### Specifications

Item no.	100692
EAN no.	5702551006924
Nail length	12 - 40 mm
Air consumption per cycle	0.5 litres
Size (LxWxH)	235 x 53 x 218 mm
Weight	1.3 kg

### Accessories

Description	Item no.
Air tool lube X-1R 100 ml	106229

### Used for

wood ceiling, fillets, backing, boarding, frames

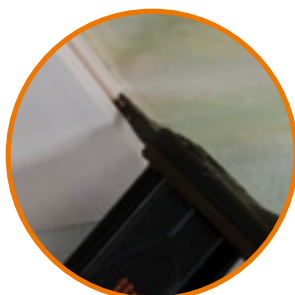

## TJEP BE-90 staples



### BE-90 staples fit

<b>TJEP</b>	90/F-18, 90/40, BN-90/40
<b>Paslode</b>	MDS 1840
<b>Senco</b>	SLS 20 stapler
<b>Haubold</b>	PN 6040 L

Dimension	Item no.	Pcs/box	Weight	Box/carton
■ BE-90, 12 mm	840112	8,000	1.80 kg	6
■ BE-90, 18 mm	840118	6,000	1.95 kg	6
■ BE-90, 25 mm	840125	4,000	1.80 kg	6
■ BE-90, 30 mm	840130	3,500	1.85 kg	6
■ BE-90, 35 mm	840135	3,000	1.85 kg	6
■ BE-90, 40 mm	840140	2,500	1.75 kg	6

### A4 stainless

Dimension	Item no.	Pcs/box	Weight	Box/carton
■ BE-90, 30 mm	840131	3,500	1.85 kg	6
■ BE-90, 35 mm	840136	3,000	1.85 kg	6
■ BE-90, 40 mm	840141	2,500	1.75 kg	6

■ Bright ■ Galv. ■ Galv., 12µ ■ HDG ■ Stainless



# TJEP ES-500/40

# TJEP ES-500 staples

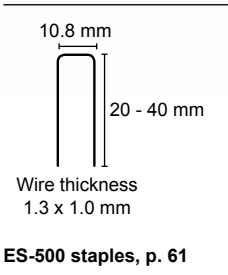
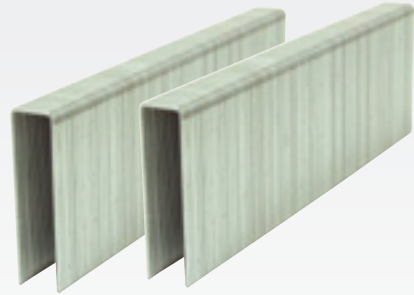

- 1 Belt hook
- 2 Silencer
- 3 Adjustable air exhaust
- 4 Adjustable depth control
- 5 Dry fire lock-out
- 6 No-mark pad

### Specifications

<b>Item no.</b>	100682
<b>EAN no.</b>	5702551006825
<b>Nail length</b>	20 - 40 mm
<b>Air consumption per cycle</b>	1.5 litres
<b>Size (LxWxH)</b>	262 x 67 x 262 mm
<b>Weight</b>	1.40 kg

### Accessories

Description	Item no.
Air tool lube X-1R 100 ml	106229

### Used for

fillets, boarding, ceiling, frames, fence, wire



### ES-500 staples fit

TJEP Haubold		ES-500/40 PN 540 L			
Dimension	Item no.	Pcs/box	Weight	Box/carton	
■ ES-500, 20 mm	841720	3,600	1.48 kg	6	
■ ES-500, 25 mm	841725	3,000	1.51 kg	6	
■ ES-500, 30 mm	841730	2,400	1.38 kg	6	
■ ES-500, 35 mm	841735	2,000	1.35 kg	6	
■ ES-500, 40 mm	841740	2,000	1.49 kg	6	

- Bright
- Galv.
- Galv., 12µ
- HDG
- Stainless

## TJEP PZ-16/50

Perfect for Fermacell  
boarding and floor  
boarding

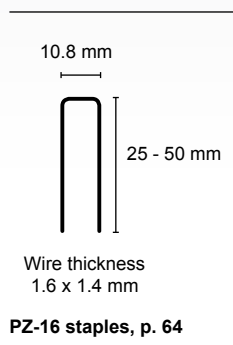

- 1 Quick open of nose if nail trapped
- 2 Incl. special nose for flooring
- 3 Adjustable depth control
- 4 Top load

### Specifications

Item no.	100699
EAN no.	5702551006993
Nail length	25 - 50 mm
Air consumption per cycle	2.5 litres
Size (LxWxH)	344 x 87 x 291 mm
Weight	2.20 kg

### Accessories

Description	Item no.
Air tool lube X-1R 100 ml	106229

### Used for

flooring, boarding, wire

## TJEP PQZ-64

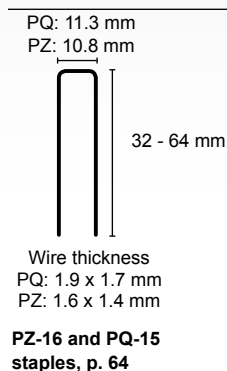

For PQ as well as PZ  
staples up to 64 mm!

- 1 Adjustable air exhaust
- 2 Quick open of nose if nail trapped
- 3 Top load
- 4 Incl. special nose for flooring

### Specifications

Item no.	100697
EAN no.	5702551006979
Nail length	32 - 64 mm
Air consumption per cycle	2.7 litres
Size (LxWxH)	353 x 106 x 331 mm
Weight	2.68 kg

### Accessories

Description	Item no.
Air tool lube X-1R 100 ml	106229

### Used for

flooring, boarding, Fermacell, wire

Always follow the directions of the flooring  
supplier when selecting nails, finish nails  
or staples for mounting floor boards



# TJEP PQZ-75 GAS 2G

**NEW**

For PQ as well as PZ staples up to 75 mm!

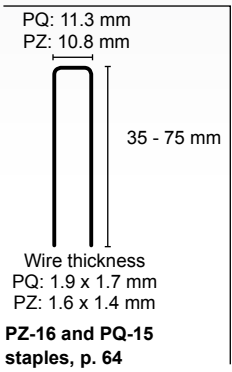

- 1 Great balance
- 2 Non-slip grip – extremely low recoil
- 3 Adjustable depth control
- 4 Top load
- 5 Smooth no-mark nose
- 6 Belt hook

**New 2012 model**

- New handle, better support
- New air filter, less maintenance
- New safety bracket, improved trigger

**Specifications**

Item no.	100836
EAN no.	5702551008362
Nail length	35 - 75 mm
Size (LxWxH)	373 x 108 x 351 mm
Weight incl. battery	3.80 kg

Supplied with 2 batteries and charger in plastic case.

**Accessories**

Description	Item no.
TJEP fuel cell, 165 mm, orange ring	100853
TJEP all-season fuel cell, 165 mm, red ring (-15°C)	100856
TJEP battery, 1.65 Ah NiMH	100842
TJEP charger for TJEP battery, 1.65 Ah NiMH	100840

**Used for**

boarding, flooring, Fermacell

**Mounting of Fermacell**  
Choose the right staple and stapler for the task!

Construction	Staple type	Staplers		
		PZ-16/50	PQZ-64	PQZ-75 GAS
Mounting – Fermacell (FC) on Fermacell and Fermacell on wood				
10 mm FC on 10 mm FC	840218 Tjep PZ-16 19 mm galv. CD	X		
12.5 mm FC on 12.5 mm FC	840216 Tjep PZ-16 19 mm galv. CD	X		
15 mm FC on 15 mm FC	840221 Tjep PZ-16 22 mm galv. CD	X		
18 mm FC on 18 mm FC	840231 Tjep PZ-16 28 mm galv. CD	X		
10 mm FC on wood	840232 Tjep PZ-16 32 mm galv. CD	X		
12.5 mm FC on wood	840238 Tjep PZ-16 38 mm galv. C	X	X	
15 mm FC on wood	840245 Tjep PZ-16 45 mm galv. C	X	X	
18 mm FC on wood	840246 Tjep PZ-16 45 mm galv. C *)	X	X	
2 x 10 mm FC on wood (2nd layer in sub-construction)	840245 Tjep PZ-16 45 mm galv. C	X	X	X
2 x 12.5 mm FC on wood (2nd layer in sub-construction)	840245 Tjep PZ-16 45 mm galv. C	X	X	X
2 x 15 mm FC on wood (2nd layer in sub-construction)	840245 Tjep PZ-16 45 mm galv. C	X	X	X
10 mm FC on wood (static)	840284 Tjep PZ-16 50 mm galv. C	X	X	X
12.5 mm FC on wood (static)	840284 Tjep PZ-16 50 mm galv. C	X	X	X
15 mm FC on wood (static)	840246 Tjep PZ-16 45 mm galv. C *)	X	X	X
18 mm FC on wood (static)	840246 Tjep PZ-16 45 mm galv. C *)	X	X	X
Mounting – Fermacell floor elements	840264 Tjep PZ-16 64 mm galv. C *)	X	X	X
≥ 20 mm (total) floor element		X	X	X
Mounting – Fermacell PowerPanel HD on wood	840218 Tjep PZ-16 19 mm galv. CD	X		
15 mm FC PowerPanel HD	840221 Tjep PZ-16 22 mm galv. CD	X		
Mounting – Fermacell PowerPanel H2O floor element	840264 Tjep PZ-16 64 mm galv. C	X	X	X
25 mm (total) PowerPanel H2O	840265 Tjep PZ-16 64 mm rustfri C	X	X	X
Mounting – Fermacell PowerPanel H2O on wood	840221 Tjep PZ-16 22 mm galv. CD	X		
12.5 mm FC PowerPanel H2O				
15 mm FC PowerPanel H2O	840238 Tjep PZ-16 38 mm galv. C	X	X	X
2x12.5 mm FC PP H2O (2nd layer in sub-construction)	840239 Tjep PZ-16 38 mm galv. C	X	X	X
2x12.5 mm FC PP H2O (2nd layer in sub-construction)	840250 Tjep PZ-16 50 mm galv. C	X	X	X
2x12.5 mm FC PP H2O (2nd layer in sub-construction)	840251 Tjep PZ-16 50 mm rustfri C	X	X	X

\*) Regular standard point  
\*) The staple is bent when penetrating the material  
\*) The 32-64 mm C-staples listed meet the applicable requirements for bearing constructions.  
Further data for mounting are found at [www.fermacell-dryingline.co.uk](http://www.fermacell-dryingline.co.uk). Stapler data are found at [www.tjep.eu](http://www.tjep.eu)

## TJEP PZ-16 staples

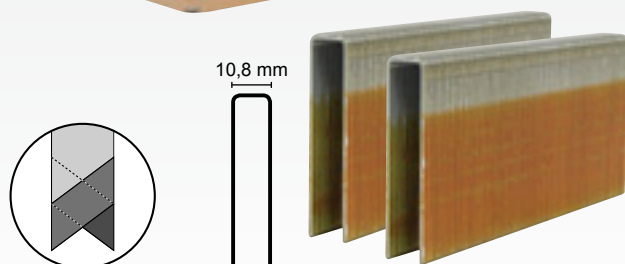

Chisel-diverted (CD) Wire thickness  
1,6 x 1,4 mm

### PZ-16 staples fit

**TJEP** PZ-16/50, PQZ-64, PQZ-75 GAS, PZ-16/64  
**Senco** SKS, SLS, SNS 41

Dimension	Item no.	Pcs/box	Weight	Box/pallet
PZ-16, 25 mm	840225	12,500	10.65 kg	76
PZ-16, 32 mm	840232	11,000	11.38 kg	76
PZ-16, 38 mm	840238	9,500	11.49 kg	72
PZ-16, 45 mm	840245	8,000	11.20 kg	76
PZ-16, 50 mm	840250	6,500	10.20 kg	72
PZ-16, 64 mm	840264	6,000	11.69 kg	72

### A4 stainless

Dimension	Item no.	Pcs/box	Weight	Box/pallet
PZ-16, 38 mm	840239	4,000	5.19 kg	63
PZ-16, 50 mm	840251	3,000	10.20 kg	84
PZ-16, 64 mm	840265	3,000	11.50 kg	144

### Chisel-diverted (CD)

Dimension	Item no.	Pcs/box	Weight	Box/pallet
PZ-16, 19 mm	840218	17,300	11.70 kg	63
PZ-16, 22 mm	840221	17,300	12.80 kg	57
PZ-16, 28 mm	840227	12,000	11.20 kg	63
PZ-16, 32 mm	840231	10,400	10.80 kg	63

■ Bright 
 ■ Galv. 
 ■ Galv., 12μ 
 ■ HDG 
 ■ Stainless

## TJEP PQ-15 staples



11,3 mm

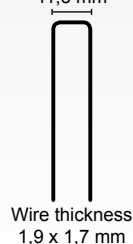

Wire thickness  
1,9 x 1,7 mm

### PQ-15 staples fit

**TJEP** PQZ-64, PQZ-75 GAS  
**Senco** SQS 55

Dimension	Item no.	Pcs/box	Weight	Box/pallet
PQ-15, 38 mm	840638	9,400	15.65 kg	57
PQ-15, 44 mm	840644	7,400	14.00 kg	54
PQ-15, 50 mm	840650	7,150	15.10 kg	54
PQ-15, 57 mm	840657	6,250	15.10 kg	57
PQ-15, 63 mm	840663	5,750	15.10 kg	54
PQ-15, 75 mm	840675	4,700	15.10 kg	57



# TJEP MF-14/150

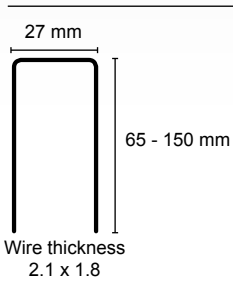
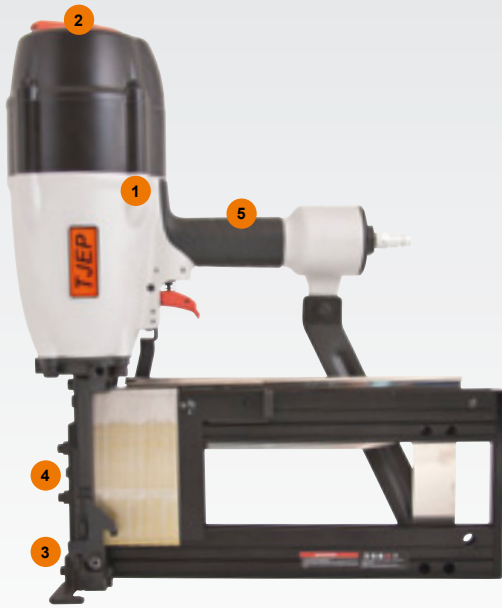

- 1 Robust gun
- 2 Adjustable air exhaust
- 3 Adjustable depth control
- 4 Quick open of nose if nail trapped
- 5 Non-slip grip

### Specifications

Item no.	100688
EAN no.	5702551006887
Nail length	65 - 150 mm
Air consumption per cycle	4.4 litres
Size (LxWxH)	470 x 130 x 400 mm
Weight	6.00 kg

### Accessories

Description	Item no.
Air tool lube X-1R 100 ml	106229

### Used for

insulation board

# TJEP MF-14 staples



### MF-14 staples fit

TJEP	MF-14/150			
Haubold	PN 29130 D			
Dimension	Item no.	Pcs/box	Weight	Box/pallet
MF-14, 110 mm	841890	1,500	9.28 kg	56

### A2 stainless

Dimension	Item no.	Pcs/box	Weight	Box/pallet
MF-14, 75 mm	841876	2,400	10.55 kg	56
MF-14, 100 mm	841891	1,800	10.25 kg	56
MF-14, 130 mm	841898	1,400	10.10 kg	56

# TJEP TW-16/38



# TJEP TW-16 staples

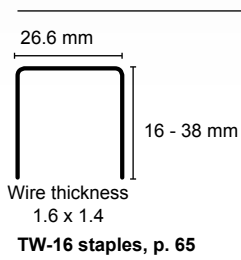

- 1 Robust gun
- 2 Adjustable support
- 3 Top load
- 4 Non-slip grip

## Specifications

Item no.	100696
EAN no.	5702551006962
Nail length	16 - 38 mm
Air consumption per cycle	1.5 litres
Size (LxWxH)	375 x 88 x 270 mm
Weight	3.07 kg

## Accessories

Description	Item no.
Air tool lube X-1R 100 ml	106229

## Used for

cardboard, fillets, boarding, packaging

## TW-16 staples fit

Dimension	Item no.	Pcs/box	Weight	Box/pallet
TW-16, 16 mm	841616	9,900	7.85 kg	72
TW-16, 22 mm	841622	7,250	7.05 kg	72
TW-16, 25 mm	841625	6,600	7.05 kg	72
TW-16, 32 mm	841632	4,650	5.98 kg	48
TW-16, 38 mm	841638	4,000	5.80 kg	72

■ Bright  
 ■ Galv.  
 ■ Galv., 12μ  
 ■ HDG  
 ■ Stainless



# Repair and service

## Maintenance of nailers

TJEP nailers are made of first-grade materials and under strict control in order to ensure many years of trouble-free use.

However, professional service and maintenance are necessary to maintain smooth and effective operation at the building site.

For almost 50 years, our TJEP service centre has been repairing pneumatic and GAS nailers from a wide range of manufacturers, such as TJEP, Paslode, DUO-FAST and MAX. This has given us great experience in all issues you might experience with a nailer.

### Use your authorized TJEP service shop

Benefit from

- 7 highly experienced technicians
- More than 4,500 different spare parts in stock
- Service and repair of TJEP, Paslode and selected models from MAX and DUO-FAST
- Service and repair within 24 hours excl. transportation.

### Please send your nailer to:

Kyocera Unimerco Fastening AS

Drejervej 2

DK-7451 Sunds

Tel.: +45 97 14 14 11

Fax: +45 97 14 14 86

E-mail: [tjep@unimerco.com](mailto:tjep@unimerco.com)





# Conversion Table

Type	TJEP nails	Page	Former name	Fits: TJEP nailers	Page	Paslode	Duo-Fast Haubold	Senco	Others	
34° strip nails	GF 34° Full head	8	GN	GRF 34/90 GAS GRF 34/105 GAS GRF 34/90 GRF 34/100 GRF 100 Compact XP	4 5 6 7	PSN98 PSN100 F-400 F-350 IM 350/90 IM 90i IM 100i			MAX GS-690 CH	
	GR 34° D-head	9	GN	GRF 34/90 GAS GRF 34/105 GAS GRF 100 Compact XP GRF 34/90 GRF 34/100	4 5 6 7 7	PSN98 PSN100 F-400 F-350 IM 350/90 IM 350/80 IM 90i IM 100i		FP 651 SP 801 SN 951 XP SN 883 GT 90 CH	Hitachi NR 90 GC2 MAX GS-690 CH SN 883 SN890CH BEA D90S-690E D 100-934C	
	DE 34° Decra	8	DE	GRF 34/90 GAS	4	IM 350/90 IM 350/80 IM 90i			MAX HN-65J	
Anchor nails	BC 15° Anchor nails	12		BC 60	13			MC 60 4Pro-BS 4060		
	KA 34° Anchor nails	15	BS	KA 4060 GAS KA-1 KA-1L KA-2	13 14 15	BS 4040 PSN 50NP F250S-PP			MAX HS 130 GS 690 RH SN 890 RH BEA R20/90S R130-958E R160-963E R100-952C	
21° strip nails	FH 21° Full head	20		FH 21/90 GAS FH 130 FH 160 FH 21/90	18 19 19 20			CN 400 CN 350 NSP 350 F SN 90 D RN 130 R	SP 800 SN 1302 FP 652 GT 90 FRH STN 130	
	TA 15° Wire-collated	22	TP	TP 45	22	3175/45		RNC 45 R	SCN 40R RP 450 RP 455	MAX CN-450R
					23			RNC 50 M1	SCN 45 SCN 48 CN 238	MAX CN-452 HN 50 HN 76 HN 75 BEA 566 DC 567 DC

Type	TJEP nails
	TF-18 0° brads, 1.2 mm
	VD-18 26° brads, 1.2 mm
	VF-16 20° finish nails
	TF-16 0° finish nails
	AB-15 34° finish nails
	VD-18 34° finish nails
	ST-18 0° finish nails
	F-18 0° finish nails

Brads and finish nails

# Conversion Table

– Which nails fit which nailers?

Only the most common products are listed – call us on +45 97 14 14 11 for further information



Type	TJEP nails	Page	Former name	Fits: TJEP nailers	Page	Paslode	Duo-Fast Haubold	Senco	Others
34° strip nails	<b>GF 34°</b> Full head	8	GN	GRF 34/90 GAS GRF 34/105 GAS GRF 34/90 GRF 34/100 GRF 100 Compact XP	4 5 6 6 7	PSN98 PSN100 F-400 F-350 IM 350/90 IM 90i IM 100i			<b>MAX</b> GS-690 CH
	<b>GR 34°</b> D-head	9	GN	GRF 34/90 GAS GRF 34/105 GAS GRF 100 Compact XP GRF 34/90 GRF 34/100	4 5 6 7 7	PSN98 PSN100 F-400 F-350 IM 350/90 IM 350/80 IM 90i IM 100i	FP 651 SP 801 SN 951 XP SN 883 GT 90 CH		<b>Hitachi</b> NR 90 GC2 <b>MAX</b> GS-690 CH SN 883 SN890CH <b>BEA</b> D90S-690E D 100-934C
	<b>DE 34°</b> Decra	8	DE	GRF 34/90 GAS	4	IM 350/90 IM 350/80 IM 90i			
Anchor nails	<b>BC 15°</b> Anchor nails	12		BC 60	12				<b>MAX</b> HN-65J
	<b>KA 34°</b> Anchor nails	15	BS	KA 4060 GAS KA-1 KA-1L KA-2	13 14 14 15	BS 4040 PSN 50NP F250S-PP		MC 60 4Pro-BS 4060	
21° strip nails	<b>FH 21°</b> Full head	20	-	FH 21/90 GAS FH 130 FH 160 FH 21/90	18 19 19 20		CN 400 CN 350 NSP 350 F SN 90 D RN 130 R	SP 800 SN 1302 FP 652 GT 90 FRH STN 130	<b>MAX</b> HS 130 GS 690 RH SN 890 RH <b>BEA</b> R20/90S R130-958E R160-963E R100-952C
Coil nails	<b>TA 15°</b> Wire-collated	22	TP	TP 45	22	3175/45	RNC 45 R	SCN 40R RP 450 RP 455	<b>MAX</b> CN-450R
	<b>MX 15°</b> Plastic-collated	23	-	MX 50	23		RNC 50 M1	SCN 45 SCN 48 CN 238	<b>MAX</b> CN-452 HN 50 HN 76 HN 75 <b>BEA</b> 566 DC 567 DC
	<b>ZE 0°</b> Plastic-collated	25	IN	ZE 65	24		CNP 50 CNP 65 CNP 75		
	<b>PC 15°</b> Plastic-collated	27	-	PC 66 PC 90	26 26		RNC 90 B RNC 65	SCN 45 SCN 65 SCN 75	<b>MAX</b> CN 565 HN-90
	<b>CN 15°</b> Wire-collated	29	TS	PC 66 PC 90 CN 57 CN 70 CN 100 EPAL	26 26 28 28 29	P-350C P-275C CNW70 CNW90	RNC 90 B RNC 65	SCN 49 SCN 60 SCN 65 SCN 57 SCN 64	<b>MAX</b> MCN 55 CN 565 CN 70 MCN 80 MCN 890 HN-90 HN-75 HN-65 <b>BEA</b> 566 DC 567 DC
Haften nails	<b>HA</b> Full head	32	-	HA 35 GAS	32	IM 200 A/35 HAFTE			
	<b>PC 15°</b> Full head	33	PC	PC 66 Haften	33		RNC 50 S/W		<b>MAX</b> CN 450 G CN 351 R
Corrugated nails	<b>CO 0°</b> Corrugated nails	36	-	CO-15	36			F 45C	<b>BEA</b> W-25
Concrete pins	<b>CP 0°</b> Concrete pins	39	-	CP-40 GAS CP-40	38 39			SPA 40	<b>Spit</b> Pulsa 700 P Pulsa 700 E Pulsa 1000 <b>BEA</b> CN 60

Type	TJEP nails	Page	Former name	Fits: TJEP nailers	Page	Paslode	Duo-Fast Haubold	Senco	Others
Brads and finish nails	<b>TF-18</b> 0° brads, 1,2 mm	44	F18	TF-18/40 TF-18/45 F-18/50 TF-18/50 GAS TF-18/55 90/F-18	42 42 43 43 44 58	TFN 1835/F-18 TFN 1850/F-18 IM 50 F-18 IM 200 F-18 FNS1850 DEB 30	K 4440	SLP 20 1,2 S 200 BN FP 18 CF 25 Akku SLP 20	<b>Dewalt</b> D51238K <b>MAX</b> NF 201 NF 255 NF 221/F-18
	<b>VD-18</b> 26° brads, 1,2 mm	45	D18	VD-18/50	45	FN 1850 A26			
	<b>VF-16</b> 20° finish nails, 1,6 mm	46	ABF16	VF-16/64 GAS	46	FN16A65 IMP250A IM65 ABF16			<b>Dewalt</b> DC618KB DC618KN
	<b>TF-16</b> 0° finish nails, 1,6 mm	49	F16	TF-16/38 F-16/50 TF-16/50F TF-16/63B TF-16/64 GAS	47 47 48 48 49	FN 1665.1 FN 1665 3250 F-16 FN1650 IMP 65 F-16 IM 250CT		S 200 SM SLP 20 1,6 FP 32 CF 32 Akku GT 65 RHS Gas	<b>Dewalt</b> D51257K DC 616 KB
	<b>AB-15</b> 34° finish nails, 1,8 mm	51	AB15	AB-15 AB-15/50 AB-15/64 GAS	50 50 51	3250 AB-15 FN1565A34		SFN 30 FP 42XP FP 35 CF 41 Akku S 250 FN GT 65 DA Gas	<b>Dewalt</b> D51276K
	<b>VD-15</b> 34° finish nails, 1,8 mm	52	D15	VD-15/50	52	FN1550A26			
	<b>ST-50</b> 0° finish nails, 1,8 mm	53	ST50	ST-15/50	53	FN1650C			
	<b>TT</b> 0° finish nails, 2,5 mm	54	T	TT-65	54				
Staples	<b>PG-50</b> W: 12.5 mm Wire: 1.3 x 0.5 mm	56	DF50	PG-50/14	56		CS 5000 LDS 5016		
	<b>BE-80</b> W: 12.8 mm Wire: 0.9 x 0.7 mm	57	80	80/16 80/16 auto	57 57		PN 814 G	SFW 05	
	<b>BE-90</b> W: 5.8 mm Wire: 1.3 x 1.0 mm	59	90	90/F-18 90/40 BN-90/40	58 58 59	MDS 1840	PN 6040 L	SLS 20 Klam.	
	<b>ES-500</b> W: 10.8 mm Wire: 1.3 x 0.5 mm	60	-	ES-500/40	60		PN 540 L		
	<b>PZ-16</b> W: 10.8 mm Wire: 1.6 x 1.4 mm	64	-	PQZ-75 GAS PQZ-64 PZ-16/50	61 62 62			SKS/SLS SNS 41	
	<b>PQ-15</b> W: 11.2 mm Wire: 1.9 x 1.6 mm	64	-	PQZ-75 GAS PQZ-64	62 62			SQS 55	
	<b>MF-14</b> W: 27 mm Wire: 2.1 x 1.8 mm	65	-	MF-14/150	65		PN 29130 D PN 29180 D	WC360 SP	
	<b>TW-16</b> W: 26.6 mm Wire: 1.6 x 1.4 mm	66	-	TW-16/38	66			WC 150 XP	
	<b>PB-18</b> W: 10.3 mm Wire: 1.3 x 0.5 mm	-	I18	I-18/38 ES-500/40	- 60	3150 -I-18			
	<b>PF-50</b> W: 12.9 mm Wire: 1.2 x 0.6 mm	-	W-50	PF-50	-	1000-W-50 SR			
	<b>PE-30</b> W: 8.5 mm Wire: 0.8 x 0.6 mm	-	S-30	PE-30/16	-	1000 S-30 SR			
	<b>RA-11</b> W: 10.6 mm	-	Type 11				HT 11		
	<b>PH-50</b> W: 5.2 mm Wire: 1.2 x 0.6 mm	-	N-50	PH-50	-	1000-N-50 SR			
	<b>PA-18</b> W: 5.2 mm Wire: 1.3 x 1.0 mm	-	N-18			3150 N-18 S150-N-18			
	<b>PV-16</b> W: 24.0 mm Wire: 1.6 x 1.4 mm	-	W-16			3150 W-16 S150-W-16			
	<b>PL-16</b> W: 13.0 mm Wire: 1.6 x 1.4 mm	-	S-16			3200 S-16 S200 S-16 IM 200 S-16			



## KYOCERA UNIMERCO Fastening A/S

KYOCERA UNIMERCO Fastening supplies a wide range of fastening solutions for the construction industry, e.g. nailers, finish nailers, rebar tiers, T-nut solutions, compressors and accessories. For nearly 50 years, the company has been selecting and developing the most user-friendly and effective fastening tools. Close cooperation with the distributors and end-users ensures professional advice about the individual products and accessories, and about optimum use and maintenance. The Danish company was established in 1964 and is headquartered in Sunds.

The company is part of the KYOCERA UNIMERCO group, founded in Denmark in 1964 and then named UNIMERCO. In 2011, all activities were acquired by Japan-based KYOCERA. This has created an even stronger company with a larger range of products, a wide network of companies and distributors all over the world, and an ambitious growth plan.

## Contact the Export department

KYOCERA UNIMERCO FASTENING A/S  
Drejervej 2 • DK-7451 Sunds • Tel: +45 97 14 14 11  
Fax: +45 97 14 14 86 • [tjep@unimerco.com](mailto:tjep@unimerco.com) • [www.tjep.eu](http://www.tjep.eu)

Dealer

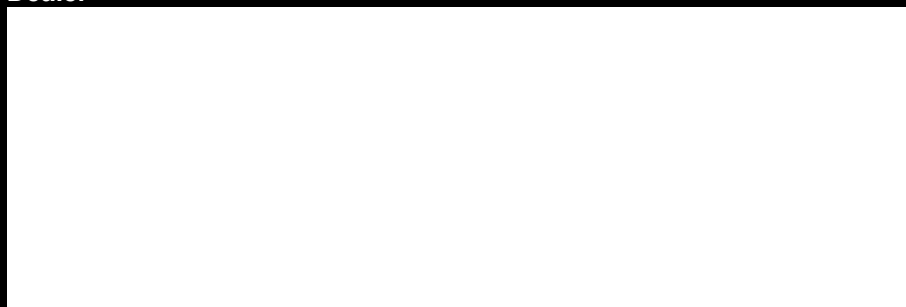

KYOCERA UNIMERCO Fastening A/S  
Drejervej 2  
DK-7451 Sunds  
Tel. +45 97 14 14 11  
Fax +45 97 14 14 86  
[tjep@unimerco.com](mailto:tjep@unimerco.com)